



Department
for Transport

Inclusive Mobility

A Guide to Best Practice on Access to
Pedestrian and Transport Infrastructure

December 2021

Department for Transport
Great Minister House
33 Horseferry Road
London
SW1P 4DR



© Crown copyright 2021

This publication is licensed under the terms of the Open Government Licence v3.0 except where otherwise stated. To view this licence, visit nationalarchives.gov.uk/doc/open-government-licence/version/3 or write to the Information Policy Team, The National Archives, Kew, London TW9 4DU, or email: psi@nationalarchives.gsi.gov.uk.

Where we have identified any third party copyright information you will need to obtain permission from the copyright holders concerned.

This publication is also available on our website at www.gov.uk/government/organisations/department-for-transport

Any enquiries regarding this publication should be sent to us at www.gov.uk/government/organisations/department-for-transport

Contents

1.	Introduction	8
1.1	Why is this guidance important?	8
1.2	What is this guidance based on?	8
1.3	What does the guidance cover?.....	9
1.4	Who is this guidance for?.....	9
1.5	Key principles.....	10
2.	Engagement, awareness raising and management.....	13
2.1	Engagement.....	13
2.2	Awareness raising and publicity.....	14
2.3	Planning for accessibility improvements	16
3.	Basic human factors information.....	17
3.1	Definitions	17
3.2	People with a mobility impairment and vision impaired people.....	19
3.3	Wheelchair users	20
3.4	Walking distances	26
4.	Footways, footpaths and pedestrian crossing facilities	27
4.1	Tonal and colour contrast.....	27
4.2	Width and height clearance.....	28
4.3	Gradients	29
4.4	Guardrails	30
4.5	Seating.....	31
4.6	Shared use routes.....	32
4.7	Street furniture	32

4.8	Surface materials and maintenance	36
4.9	Street works and other potential hazards	37
4.10	Road crossings	39
4.11	Dropped kerbs and raised crossings	43
5.	Changes in level	45
5.1	Steps and stairs	45
5.2	Ramps	47
5.3	Handrails	50
5.4	Escalators	51
5.5	Travelators / Moving walkways	52
5.6	Lifts	52
5.7	Footbridges, tunnels and underpasses	59
5.8	Platforms: rail services	59
5.9	Platforms: rail services off-street	62
5.10	Platforms: rail services on-street	62
6.	Tactile paving surfaces	63
6.1	Blister paving surface for use at pedestrian crossing points	65
6.2	Corduroy hazard warning surface	65
6.3	Platform edge (on-street) warning surface	66
6.4	Segregated shared cycle track/footway surface (Ladder and Tramline) and central delineator strip	66
6.5	Guidance path surface	67
6.6	Platform edge (off-street) warning surface	68
7.	Making cycling facilities accessible to all	69
7.1	The importance of making cycling infrastructure accessible	69
7.2	Cycles as a mobility aid	69
7.3	General design principles for cycling infrastructure	70
7.4	Cycle parking	72
7.5	Signing	73

7.6	Traffic calming, speed reduction and access control measures	74
7.7	Surface materials and maintenance.....	74
7.8	Making cycling infrastructure safe for disabled pedestrians.....	74
8.	Car parking	76
8.1	General Provision.....	76
8.2	The recommended number of designated accessible spaces in different contexts	77
8.3	The design of accessible parking spaces: off-street	78
8.4	The design of accessible parking spaces: on-street	80
8.5	Control systems associated with designated accessible spaces	82
9.	Bus, Light Rapid Transit (LRT) and tram stops.....	84
9.1	The siting of bus stops	84
9.2	Raised bus boarding areas	85
9.3	Shelters	85
9.4	Seating at stops	87
9.5	Stop flags	87
9.6	Timetable information.....	89
9.7	Bus stop bypasses	90
10.	Taxi ranks	91
11.	Transport buildings: access and facilities.....	92
11.1	The location of stations, terminals and interchanges	92
11.2	Entrances and doors	93
11.3	Passageways and general access within buildings.....	97
11.4	Ticketing and information	98
11.5	Seating and the design of waiting and refreshment areas	101
11.6	Luggage facilities	103
11.7	Toilets.....	104
11.8	Provision for assistance dogs.....	108
12.	The use of digital technology in public transport.....	109

12.1	Touchscreens	109
12.2	Contactless ticketing.....	111
12.3	Real-time information	111
12.4	Wayfinding technologies for pedestrians	113
13.	Signing and information.....	115
13.1	The size of text and symbols on signs.....	115
13.2	Choice of fonts.....	117
13.3	Tonal and colour contrast.....	117
13.4	Positioning of signs.....	118
13.5	Tactile signs and labelling	118
13.6	Audible information.....	119
13.7	Timetables	119
14.	Lighting.....	121
15.	Access in the countryside.....	123
	Glossary	126
	Bibliography	128

List of Figures

Figure 1: Footway widths headroom requirements and guardrails	30
Figure 2: Low-level obstructions	35
Figure 3: Street works protection	37
Figure 4: Stairs	45
Figure 5: Ramps	48
Figure 6: Lift interior	55
Figure 7: Lift exterior	54
Figure 8: Rail platform	60
Figure 9: Six tactile paving surfaces	63
Figure 10: Off-street parking	78
Figure 11: On-street parking at an angle to a kerb	80
Figure 12: On-street parking parallel to a kerb	80
Figure 13: Bus stop	87
Figure 14: Manually operated doors	95
Figure 15: Automatic sliding doors	96
Figure 16: Ticketing / information counter	100
Figure 17: Waiting and refreshment facilities	102
Figure 18: Toilet door	103
Figure 19: Toilet interior	104
Figure 20: Rural bridge	124

1. Introduction

1.1 Why is this guidance important?

This document is a guide to best practice on access to pedestrian and transport infrastructure.

Creating and maintaining an accessible public realm is crucial for ensuring that disabled people are not excluded from playing a full role in society.

1.2 What is this guidance based on?

This document supersedes Inclusive Mobility first published by the Department for Transport in 2002. It does not change the principles of the original guidance document, which explained the background and how it was originally developed.

This update includes responses to some recommendations of research carried out as a commitment in the Department for Transport's Inclusive Transport Strategy of 2018, and following engagement with disabled people and representative groups, and with practitioners. The research report is also available on the Department's website.

This document has been updated with references to other key documents including: British Standard BS 8300; the Approved Documents for the Building Regulations; The Traffic Signs Regulations and General Directions 2016, The Traffic Signs Manual, Design Standards for Accessible Railway Stations - A joint Code of Practice published by the UK Department for Transport and Transport Scotland in 2015; Traffic Advisory Leaflets; and Local Transport Note 1/20: Cycle Infrastructure Design. It also refers to the latest version of the Department for Transport publication Guidance on the Use of Tactile Paving Surfaces.

1.3 What does the guidance cover?

This guidance describes features that need to be considered in the provision of an inclusive environment and issues related to disabling barriers, the use of technology, maintenance, awareness of the needs of disabled people, and engagement. Throughout the document, references to pedestrians and walking include people using: mobility aids such as wheelchairs and rollators; 'invalid carriages' including mobility scooters designed for use on the **footway**, and people with physical, sensory or cognitive impairments who are travelling on foot. The term 'electric wheelchair' relates to wheeled mobility aids that are often referred to as 'powered wheelchairs'.

Although the main purpose of this guidance is to provide good access for disabled people, designs that satisfy their requirements also meet the needs of many other people. People travelling with small children or carrying luggage or heavy shopping will all benefit from an accessible environment, as will people with temporary mobility problems (e.g. a leg in plaster) and many older people. Good, inclusive design benefits all users, including those who have non-visible disabilities. The overall objective of this guide is to enable practitioners to provide an inclusively designed public realm, and through that help achieve social inclusion.

1.4 Who is this guidance for?

This guidance is for use by anyone designing and installing public realm schemes and improvements, including local authorities and their consultants, highways practitioners, and urban designers. It applies to both new build schemes and upgrades to existing layouts. It is primarily aimed at transport infrastructure and the public highway but much of its advice is relevant to private land accessible to the public. It provides good practice on designing the public realm to be accessible to all and should be followed as a matter of course for all such schemes.

The use of this guidance will support creating and maintaining an inclusive and accessible built environment, and related activities carried out in compliance with requirements of the Equality Act and the public sector Equality Duty set out in the Equality Act 2010. The guidance will also be of interest to those looking to make reasonable adjustments in response to the requirements set out in Section 20 of the Act.

1.5 Key principles

The following principles apply to the use of this guidance.

1.5.1 Inclusive Design

Inclusive design requires that the needs of all disabled people are considered from the outset of any transport and pedestrian infrastructure, including maintenance, schemes., so that, for example, tactile paving surfaces provided for vision impaired people do not create trip hazards or cause undue discomfort to people with conditions such as arthritis.

The use of this guidance, and engagement as described in Chapter 2, should therefore be considered from the earliest stages of proposals for such schemes.

The research undertaken to inform the update to this guidance included an investigation of the accessibility needs of people with mental health conditions, dementia, and age-related and non-visible impairments. This identified various related barriers to navigating the pedestrian environment, including obstacles, uneven surfaces, crossing the road, navigating slopes and ramps, and lack of confidence to travel. It also concluded that these barriers have a relatively high impact on people with mental health conditions, who are consequently more likely to be deterred by them from travelling. These users will therefore benefit from pedestrian environments that are simpler, with distinct features and provision of clear information, which will aid navigation and give people confidence to travel. In addition, a well-designed and accessible environment brings wider benefits for the general population, such as those travelling with children, especially in pushchairs, or those with heavy luggage.

1.5.2 The Equality Act and public sector Equality Duty

The Equality Act 2010 legally protects people from discrimination in the workplace and in wider society: information on the Act is available on GOV.UK and is summarised below. Discrimination can come in one of the following forms:

- direct discrimination - treating someone with a protected characteristic less favourably than others

- indirect discrimination - putting rules or arrangements in place that apply to everyone, but that put someone with a protected characteristic at an unfair disadvantage

It is against the law to discriminate against anyone because of these “protected characteristics”:

- age
- gender reassignment
- being married or in a civil partnership
- being pregnant or on maternity leave
- disability
- race including colour, nationality, ethnic or national origin
- religion or belief
- sex
- sexual orientation

The public sector Equality Duty (section 149 of the Act) came into force on 5 April 2011. The Equality Duty applies to public bodies and others carrying out public functions. It supports good decision-making by ensuring public bodies consider how different people will be affected by their activities, helping them to deliver policies and services which are efficient and effective, accessible to all, and which meet different people’s needs. The Equality Duty is supported by specific duties, set out in regulations which came into force on 10 September 2011.

The Equality Duty requires public authorities, in carrying out their functions, to have due regard to the need to achieve the objectives set out under s149 of the Equality Act 2010 to:

- eliminate discrimination, harassment, victimisation and any other conduct prohibited by the Act
- advance equality of opportunity between persons who share a protected characteristic and persons who do not share it

- foster good relations between persons who share a relevant protected characteristic and persons who do not share it

This guidance sets out good practice in the creation and maintenance of an accessible and inclusive built environment and public realm. It should be considered an essential document for those seeking to produce an inclusive environment and meeting the requirements of the Act, including the public sector Equality Duty, and other legislation.

2. Engagement, awareness raising and management

2.1 Engagement

Authorities or other agencies, and their designers and practitioners should carry out appropriately diverse engagement when considering, developing and introducing schemes.

People's needs differ greatly, and engagement should be a constructive process used in order to ensure that these needs are understood and responded to. Engagement should include a wide and appropriate range of people who have a protected characteristic defined in the Equality Act 2010. This will include disabled people, such as: mobility impaired people, including wheelchair users; people with non-visible impairments; older people; vision impaired people; people with a hearing impairment; people with a learning difference and other neurodiverse people. Effective engagement enables designs and schemes to be tested with end-users, maximising inclusivity.

Planners and designers should also engage with other key stakeholders, such as local authority access officers, other equality & diversity professionals, engineers, architects, surveyors and transport providers.

Engagement should continue throughout a project, contribute to the design, and might include user tests and trials.

Advice is also available from a variety of local organisations and national disabled people's organisations such as the Royal National Institute of Blind People (RNIB) and the Royal National Institute for Deaf People (RNID), and Disability Rights UK. Advice on engagement with stakeholders and on engaging with people with non-visible impairments is provided in the Department for Transport publications Local Cycling and Walking Infrastructure Plans: Technical Guidance for Local Authorities and Local Transport Note (LTN) 1/20 on cycle infrastructure design. The latter also advises on the importance of engagement with local groups representing the interests of disabled people and has references relating to consideration for visually impaired people throughout.

2.2 Awareness raising and publicity

This guidance is mainly concerned with designs that will remove barriers and so improve access and inclusion. However, people can be disabled by the attitudes of others as well as their environment. Therefore, disability awareness training, including for staff in with direct contact with the public, is also essential for access and inclusion. Similarly, those involved with activities such as designing, planning and managing facilities and services should have a good knowledge of the diverse needs of the customers and users.

Senior managers need to understand the implications of the Equality Act 2010 and how policies, strategies, procedures, planning, investment, infrastructure and operations can be arranged so that:

- investment opportunities are not wasted
- investment helps meet the requirements of the Equality Act 2010
- the guidance and standards set out in this document are built into routine maintenance and construction projects to avoid mistakes that may be expensive to rectify and to help ensure compliance with the Equality Act 2010;
- all policies, practices and procedures, at every location, used by the public comply with the Equality Act 2010

Staff who are in regular contact with the public need to have awareness of how to serve disabled people without discrimination and how to mitigate the effects of any barriers experienced with premises, vehicles and services. All staff need to be able to ‘think on their feet’ in unexpected situations or in an emergency.

Some transport operators and other organisations have produced training programmes on disability awareness that are available to third parties. Training in disability awareness should form part of both induction training and refresher or promotion courses for staff. Disabled people should be involved in the design of training programmes, as well as in their delivery, where possible.

The Department for Transport has put in place the Inclusive Transport Leaders Scheme and the REAL disability equality training programme, delivering Inclusive Transport Strategy commitments.

The Inclusive Transport Leaders Scheme supports operators making their services more accessible, putting disabled passengers at the heart of their service provision, and improving confidence and skills in delivering inclusive journeys for disabled passengers.

The REAL training programme provides the basis for training managers to put together a range of agendas, from induction briefings on disability to whole-day programmes and refresher interventions.

Training should be tailored to the particular job function, but in general programmes should include (as appropriate):

- barriers faced by disabled people, including attitude, environment and organisation
- principles of access audits
- suggestions for removing barriers faced by disabled people
- information on the range of impairments, including those that are non-visible
- the skills needed for assisting disabled travellers
- communication and interpersonal skills for interacting positively with disabled people, particularly those with a hearing impairment
- general awareness of the Equality Act 2010

When access to an existing facility or service is improved, or when a new accessible facility is built, disabled people who may use and benefit from the improvements should be made aware of them. The methods used to bring improvements to the attention of disabled people will vary but may include direct correspondence with local organisations of disabled people, announcements in the local press, on local radio, on websites or using social media, or through leaflets and advertising.

Apart from the need to inform people about changes in accessibility, there is a more general requirement to make sure that people are aware of the level of access at stations and other transport infrastructure. This information should be available in a variety of formats so that, for example, vision impaired as well as sighted people can obtain the information.

2.3 Planning for accessibility improvements

The accessibility of infrastructure can be much improved as part of on-going repairs, maintenance and modernisation schedules. Such improvements can be made at a lower cost and with less disruption than if the improvements are made separately. For example, resurfacing a footway may provide the opportunity to clear some of the clutter often found in the pedestrian environment, and so remove barriers to movement. Relevant staff should be made aware of the importance of doing this.

British Standard BS EN 17210:2021 Accessibility and Usability of the Built Environment. Functional Requirements describes the basic, minimum functional requirements and recommendations for an accessible and usable built environment, following Universal Design principles. This will facilitate impartial and safe practice for a wide range of users, including disabled people.

3. Basic human factors information

3.1 Definitions

It is essential that design for disabled people should be to the highest possible standards. This section provides information on the basic human requirements for ease of movement. In designing or modifying facilities the aim should be to be generous in the allocation of space.

The term “disability” is a broad one. It includes people with a physical or sensory impairment including mobility and vision impairment, neurodiverse people including people who have a neurological or learning difference, and people living with chronic health conditions which are not visible and which impact mobility, for instance a heart condition or breathing difficulties. Legislation defines a person as having a disability if they have a physical or mental impairment which has a substantial and long-term adverse effect on their ability to carry out normal day-to-day activities. Many, though not all, disabled people face barriers to movement in the environment. This guide is intended to show how these barriers can be removed or at least reduced. It also has a wider relevance because there are many people not conventionally considered to have an impairment who also encounter barriers to movement.

People with small children, carrying heavy shopping or luggage, people with temporary accident injuries and older people can all benefit from good design of the pedestrian and public transport environment. Without a barrier free environment, many of these people will have their mobility impaired.

There are many aspects of design in the pedestrian environment that are helpful to all or most disabled people (and others), but some need specific facilities.

Manual wheelchair users need sufficient space to be able to propel the chair without banging their elbows or knuckles on door-frames or other obstacles. There are also many other examples where some people, either accompanied or travelling alone, may require extra space. Someone who

walks with sticks or crutches or a rollator needs more space than a non-disabled walker; so too does a long-cane user or person carrying luggage or shopping. Thus, providing adequate clear space on pavements, along passages in public buildings, through doorways and so on, is of benefit to many people.

Similarly, vision impaired people need good levels of even lighting in transport buildings and elsewhere and, similarly, information such as train or bus timetables should be in a font size that enables them to be easily read. But almost everyone benefits from good lighting, not least because it gives a greater sense of security and practically everyone finds reading timetables easier if the print is clear and large.

These are just two examples of design requirements that are essential for people with a particular impairment but which have a much wider relevance.

For people with certain types of impairment more specific needs can be just as important. For example, the rotating cone below the push button box on a controlled pedestrian crossing is essential if a deafblind person and can be helpful for other pedestrians including blind or partially sighted people to know when the 'Green Walking Symbol' signal is lit.

This guidance provides advice on both those requirements that are general in nature and those that are more specific.

There are various ways or models used to define disability, but in functional terms this guidance is mainly concerned with the following:

- mobility impairments: includes people who use wheelchairs and those who can walk but only with difficulty, often using some form of aid such as a stick or walking frame. Approaching 70% of disabled people have a mobility impairment; those with walking difficulties outnumber wheelchair users by about 10:1
- vision impairments: vision impaired people include blind people and partially sighted people. According to the National Health Service (www.nhs.uk/conditions/vision-loss), there are almost 2 million people in the UK living with sight loss. Of these, around 360,000 are registered as blind or partially sighted

- hearing impairments: RNID reports that there are 12 million people in the UK with hearing loss greater than 25dB, of whom 151,000 are British Sign Language (BSL) users (www.rnid.org.uk)
- limitations with reaching, stretching and dexterity: these are frequently the result of arthritis, which can make these movements painful and difficult, or of muscular dystrophy causing a loss of muscular strength, or of complaints of the nervous system
- neurological and learning differences: including those making it hard to understand complicated information or use complex machines (like some ticket machines)

It should be remembered that these categories are not mutually exclusive. Many disabled people, particularly older people, have more than one impairment.

The following paragraphs give some basic information on the space needed by people when they are standing or moving. There is much variation in this, but if the dimensions given below are used then the majority of disabled people will be able to move around buildings and the environment more easily.

3.2 People with a mobility impairment and vision impaired people

Someone who does not use a walking aid can walk along a passageway less than 700mm wide, but just using a stick requires greater width than this: a minimum of **750mm**. A person who uses two sticks or crutches, or a walking frame, needs a minimum of **900mm**, while a vision impaired person using a long cane, or with an assistance dog, needs **1100mm**. A vision impaired person being guided needs a width of **1200mm**. A wheelchair user and a non-wheelchair using person side-by-side need **1500mm** width. Paragraph 4.2 provides guidance on footways and footpaths as wide as practicable and a minimum width of **2000mm** under normal circumstances.

Unobstructed height above a pedestrian way is also important, especially for vision impaired people. Generally, this should be a minimum of **2300mm**, except on sub-surface station platforms, where it should be **3000mm**. Where a sign is suspended over a **footway** or pedestrian area, for example in a

railway station, a minimum clearance of **2100mm** is acceptable (**2300mm** on cycle routes). Where trees and similar overhang a footway, they should be managed, as described in Section 4.2, to maintain a minimum of 2300mm unobstructed height above the pedestrian way.

3.3 Wheelchair users

Although a minority among disabled people, wheelchair users need quite a lot of space to move around comfortably and safely, while those who walk with two sticks can occupy a greater width than someone using a wheelchair.

A comprehensive set of measurements of wheelchair users visiting the Mobility Roadshow (1999) provides figures for length and width summarised here. The range of dimensions is considerable, particularly that for overall length. The greatest lengths are those for conventional wheelchair users with a leg support (maximum **1545mm**, though this was the only measurement of 745 that exceeded 1500mm) and electric mobility scooters (with a maximum of **1500mm**). Conventionally, seated wheelchair users do not occupy more than approximately **1250mm**. However, if a wheelchair user has a personal assistant their combined length will typically be **1750mm**. The figures given for width, with a 95th percentile of slightly over **700mm** at maximum (for powered chairs), do not make allowance for the wheelchair user's elbows and hands. The ISO standard for wheelchairs (ISO 7193) notes that propelling a wheelchair manually needs a minimum clearance of **50mm**, and preferably **100mm**, on both sides.

The Mobility Roadshow survey also measured the height of wheelchair users. The overall mean height for all types of wheelchair users was **1243mm**, with a 5th percentile of **1076mm**, 95th percentile of **1374mm** and a maximum of just over **1450mm**. As with overall length, mobility scooter users gave slightly greater height figures, with a mean height of **1340mm**, 5th and 95th percentiles of **1202mm** and **1438mm**, respectively, and a maximum of **1502mm**.

Other basic measurements that are of importance when considering design standards for wheelchair users are:

- eye height, which is around **120-130mm** below seated height, giving a 5th-95th percentile range for wheelchair users from **960mm** to **1250mm** (**1080mm** to **1315mm** for mobility scooter users)
- knee height, **500mm** to **690mm**
- seat height, **460mm** to **490mm**
- ankle height, manual wheelchair users **175mm** to **300mm**; electric/powered wheelchair users **380mm** to **520mm**
- height to bottom of foot support, **60mm** to **150mm**

The ability of a person in a wheelchair to reach, sideways or forward, is also important and a number of guidelines give figures for this. These are summarised in the following tables:

Wheelchair type	Mean (mm)	Min (mm)	Max (mm)	5th percentile (mm)	95th percentile (mm)
Attendant propelled	1080	742	1318	928	1197
Electric/ powered wheelchair	1107	758	1549	949	1328
Manual wheelchair	1033	707	1256	846	1183
Older style manual wheelchair	1108	862	1357	919	1267
Mobility scooter	1187	971	1500	1000	1402
All wheelchairs	1085	707	1549	894	1273

Length of wheelchair and user (excluding children)

(Source: A survey of occupied wheelchairs to determine their overall dimensions and weight: 1999 survey by R.E. Stait, J. Stone and T.A. Savill. (Unpublished Project Report, Transport Research Laboratory).

Wheelchair type	Mean (mm)	Min (mm)	Max (mm)	5th percentile (mm)	95th percentile (mm)
Attendant propelled	596	520	674	528	658
Electric/ powered wheelchair	635	521	755	552	706
Manual wheelchair	638	511	741	579	702
Older style manual wheelchair	616	511	722	560	686
Mobility scooter	607	501	695	529	685
All wheelchairs	627	501	755	558	695

Width of wheelchair (excluding children)

(Source: A survey of occupied wheelchairs to determine their overall dimensions and weight: 1999 survey by R.E. Stait, J. Stone and T.A. Savill. (Unpublished Project Report, Transport Research Laboratory)).

The distance that an individual can reach varies with both the size of the person and the height to which they are reaching. Reach distance forms an arc based on the shoulder level of the wheelchair user, and can be defined as ‘easy’ or ‘comfortable’ (reach without much movement of the torso) and ‘maximum’ or ‘extended’ (just possible with movement of the torso). Figures shown in the table below are taken from research conducted for the BS 8300 Code of Practice.

Person	Access	Reach angle	Height		Depth	
Wheelchair user	Front	+70°	1000	1150	90	120
		Horizontal	(750)	(750)	180	230
		-24°	650	650	120	200
Wheelchair user	Side	+70°	1060	1170	100	135
		Horizontal	(750)	(750)	220	310
		-24°	665	630	165	230
Non-wheelchair user	Front	+70°	1500	1625	200	250
		Horizontal	(850)	(850)	280	400
		-24°	750	700	180	310

Dimensions associated with comfortable and extended reach ranges

Note 1. Dimensions have been rounded to the nearest 5mm.

Note 2. Dimensions in brackets are for the horizontal reference plane.

Note 3. It is assumed that any kneehole allows full reach capabilities.

Note 4. Maximum heights measured from the 70° line; minimum heights from the -24° line.

Note 5. For some activities the recommended dimensions in the standard are extended beyond those resulting from the research trials, on the basis of accepted practice.

(Source: BS 8300 Design of Buildings and their Approaches to Meet the Needs of Disabled People – Code of Practice).

The height of the feature button, handle etc. that the wheelchair user has to reach is also important. As a general rule, any features intended for use by wheelchair users, such as push buttons, switches, coin slots etc., should be no less than **750mm** and no more than **1200mm** above ground level. By leaning forward or sideways, it is possible for a wheelchair user to reach beyond this range. US data suggest an absolute range for sideways reach height from 230mm to 1370mm, but placing controls or other features towards the extremes of this range should be avoided if at all possible.

Forward reach measurements are also important. Some wheelchair users find it difficult or impossible to lean forward: if practicable, the distance forward, measured at chest height, should be no more than **500mm**; **600mm** should be the absolute maximum.

Manoeuvring space is needed for a wheelchair to turn corners or turn around. Skilled users of a manual wheelchair can turn through 360° in a space no more than **1500mm x 1500mm**, but this is insufficient for attendant propelled manual wheelchairs, larger wheelchairs, particularly outdoor electric versions (turning circle **2420mm**), electric pavement vehicles (turning circle **4350mm**) and for wheelchair users with an extended leg rest. Within transport-related buildings, the following dimensions should be taken as the minima acceptable:

- right angle turn (along corridor) **1200mm x 1200mm**
- 180° turn (within corridor) **1600mm (width) x 2000mm (length)**

Users of mobility scooters and large electric/ powered wheelchairs may need greater space than this for 180° turns, but the dimensions given (as a minimum) will accommodate users of self-propelled wheelchairs and the majority of electrically powered wheelchairs.

3.4 Walking distances

Recommended walking distances

The figures in the following table are average recommendations - there is much variation between individuals. Gradients, weather conditions, whether there are handrails and other factors will also affect the distances people are able to walk.

	Recommended distance limit without a rest
Wheelchair users	150 metres
Vision impaired people	150 metres
Walking stick and cane users	50 metres
Mobility impaired people without a walking stick	100 metres

Research based on a follow-up study to the London Area Travel Survey found that of all the people with an impairment who were able to walk at all, approximately 30% could manage no more than 50 metres without stopping or severe discomfort and a further 20% could only manage between 50 and 200 metres.

Standing is difficult and painful for some people, particularly those with arthritis, rheumatism and back problems. In the same study as that mentioned above, 9% of the survey respondents could stand for less than a minute without discomfort, 24% could manage between one and five minutes and a further 22% could stand for up to ten minutes. The findings from this study emphasise the importance of providing plenty of appropriately placed and designed seating at places where people may have to wait, and along pedestrian routes.

4. Footways, footpaths and pedestrian crossing facilities

This section focuses on outdoor facilities for pedestrians. It includes guidance on accessible footways and footpaths, on seating and other street furniture, and making controlled and uncontrolled pedestrian crossing facilities accessible.

When a 'footway' is mentioned in this document, it refers to the (usually raised) 'pavement' adjacent to a road. A 'footway' is defined in section 329 of the Highways Act 1980 as the part of the highway on which pedestrians have a right of way, alongside the part of the highway that is meant for the passage of vehicles. A 'footpath' refers to any other right of way for pedestrians, that does not run adjacent to a road, usually a Public Right of Way. Footways and footpaths should generally be treated the same in terms of design and the needs of users.

Section 11.3 provides guidance on pedestrian access within buildings.

4.1 Tonal and colour contrast

Many guidelines advocate the use of tonal and colour contrast to identify street furniture, railing or boarding around street works, scaffolding and so on. The main purpose is to help vision impaired people avoid obstacles they might walk into or trip over.

Tonally and colour contrasting bands on poles, and similar obstructions, should be approximately **150mm** in depth, with the lower edge of the band approximately **1500mm** from the ground. Colour contrast is also necessary on structures such as guard rails, glass doors and on bus shelters.

The principles underlying tonal and colour contrast have been researched in detail but, in summary, it is essential to ensure that the colours used contrast with their surroundings. Colours that appear to be different from one another in colour can be very similar tonally (e.g. green and brown) and therefore do not give sufficient contrast. Contrast is the difference in reflectivity between two surfaces.

An easy way of judging whether there is good contrast is to take a black and white photograph of the scene or a black and white photocopy of a colour photograph. Good contrast will show up black and white, poor contrast will show up as grey.

4.2 Width and height clearance

Footways and footpaths should be made as wide as is practicable, but under normal circumstances, a width of **2000mm** is the minimum that should be provided, as this allows enough space for two wheelchair users to pass, even if they are using larger electric mobility scooters. If this is not feasible due to physical constraints, then a minimum width of **1500mm** could be regarded as the minimum acceptable under most circumstances, as this should enable a wheelchair user and a walker to pass each other. Where there is an obstacle, such as lamp columns, sign posts or electric vehicle charging points, the absolute minimum width should be **1000mm**, but the maximum length of such a restricted space should be **6 metres**.

Unobstructed height above a pedestrian way is also important, especially for vision impaired people. Generally, this should be a minimum of **2300mm**, except on sub-surface station platforms, where it should be **3000mm**. Where a sign is suspended over a footway or pedestrian area, for example in a railway station, a minimum clearance of **2100mm** is acceptable (**2300mm** on cycleways). Signs should be placed at a height that is appropriate for those for whom the message is intended. For example, signs for cyclists should be placed at a height that makes them legible from a good distance, but they should also be legible for recumbent cyclists.

Where trees overhang a footway, the management of them, covered by Forestry Commission Operations Note 051 Highway Tree Management (available on GOV.UK), should ensure the maintenance of a minimum of 2300mm unobstructed height above the pedestrian way. The specific approach and height of pruning to ensure this is maintained after regrowth will need to be carried out to appropriate arboriculture standards, taking into consideration the tree species and how they respond to targeted pruning, avoiding clearance issues that can arise if branches regrow rapidly.

Tapering overhead obstructions, such as a flight of steps with an open area underneath, can constitute a particularly dangerous hazard for many,

especially vision impaired people. Therefore, any part of the underside of a stairway that does not provide the minimum **2100mm** clearance should have a barrier across or around it to warn vision impaired pedestrians.

4.3 Gradients

An environment that appears to be relatively flat might nevertheless present problems for some. For example, a continuous shallow slope that runs for a considerable distance might be an obstacle for users of a manual wheelchair, or people who can negotiate gradients over a short distance only, before experiencing pain, breathlessness or fatigue.

A crossfall on footways and footpaths may be necessary to provide good drainage but if too great these, like undulating terrain, can make it difficult for wheelchair users and other people with a mobility or balance impairment.

Generally, pedestrian environments should be level, which means that there should be no gradient in excess of 1 in 60. Effort should be made to ensure that the route is smooth, since even small dips or gaps in paving joints might present a hazard such as to people who use a stick or a crutch. If a level route is not feasible, then gradients should not exceed **1 in 20**. (A slope steeper than this is generally defined as a 'ramp').

Even if a pedestrian route has no slopes in excess of 1 in 20, it is important that there are level sections, or 'landings', at regular intervals. This is to provide people with an opportunity to rest; where possible accessible seating should be provided on such landings. A level landing should be provided for every **500mm** that the route rises. The length of each landing should be equal to at least the width of the ramp.

Gradients steeper than 1 in 20 can be managed by some wheelchair users, but only over very short distances (1000mm or less), for example on a ramp between a bus entrance and the pavement. Even over these short distances the maximum gradient used should be no more than **1 in 10**. As a general rule, however, **1 in 12** should be the absolute maximum. Not only is the physical effort of getting up a steeper gradient beyond many wheelchair users, but there is also a risk of the wheelchair toppling over.

Should a crossfall be necessary for drainage, then it is preferable to have a crossfall between 1 and 2 per cent (up to **1 in 50**) with **1 in 40** the maximum

acceptable crossfall gradient . Variable crossfalls can cause problems for wheelchair users and people who have a mobility impairment, so should be avoided wherever possible. This may be an issue where a **footway** has vehicle cross-overs, and should be taken into account by local authorities in relation to their policy on front garden parking in residential areas.

4.4 Guardrails

Where a footway has a hazard such as a steep slope or drop adjacent to it, precautions such as guardrails should be installed where there is no alternative such as a redesign to remove the hazard. Caution should be exercised in making a decision to install guardrails and an assessment procedure is provided in Local Transport Note LTN 2/09 Pedestrian Guardrailing.

Where there is no realistic alternative to installing guardrails adjacent to a **footway**, it should not encroach on the minimum width required, and should be at least **1100mm** high, preferably **1200mm**, measured from ground level. If the guardrail has a top rail that is intended to provide support, this should be cylindrical in profile, with a diameter of between **40mm** and **50mm**.

Guardrails should be designed to prevent guide dogs from walking under the rails and with sufficient openings between vertical members for small children and wheelchair users to be seen through them.

There should be an upstand at least **150mm** in height at the edge of the **footway** to act as both a tapping rail for long cane users and an additional safeguard for wheelchair users. Any gap beneath guardrails should be small enough to prevent the foot plate or front wheel of a wheelchair from snagging.

Guardrails should not have projections or overhangs which might cause a hazard for pedestrians.

Guardrails should also be in a colour that provides a contrast with their surroundings: as a minimum, they should have tonal and colour contrasted markings to make them conspicuous within their environment.

Figure 1: Footway widths, headroom requirements and guardrails

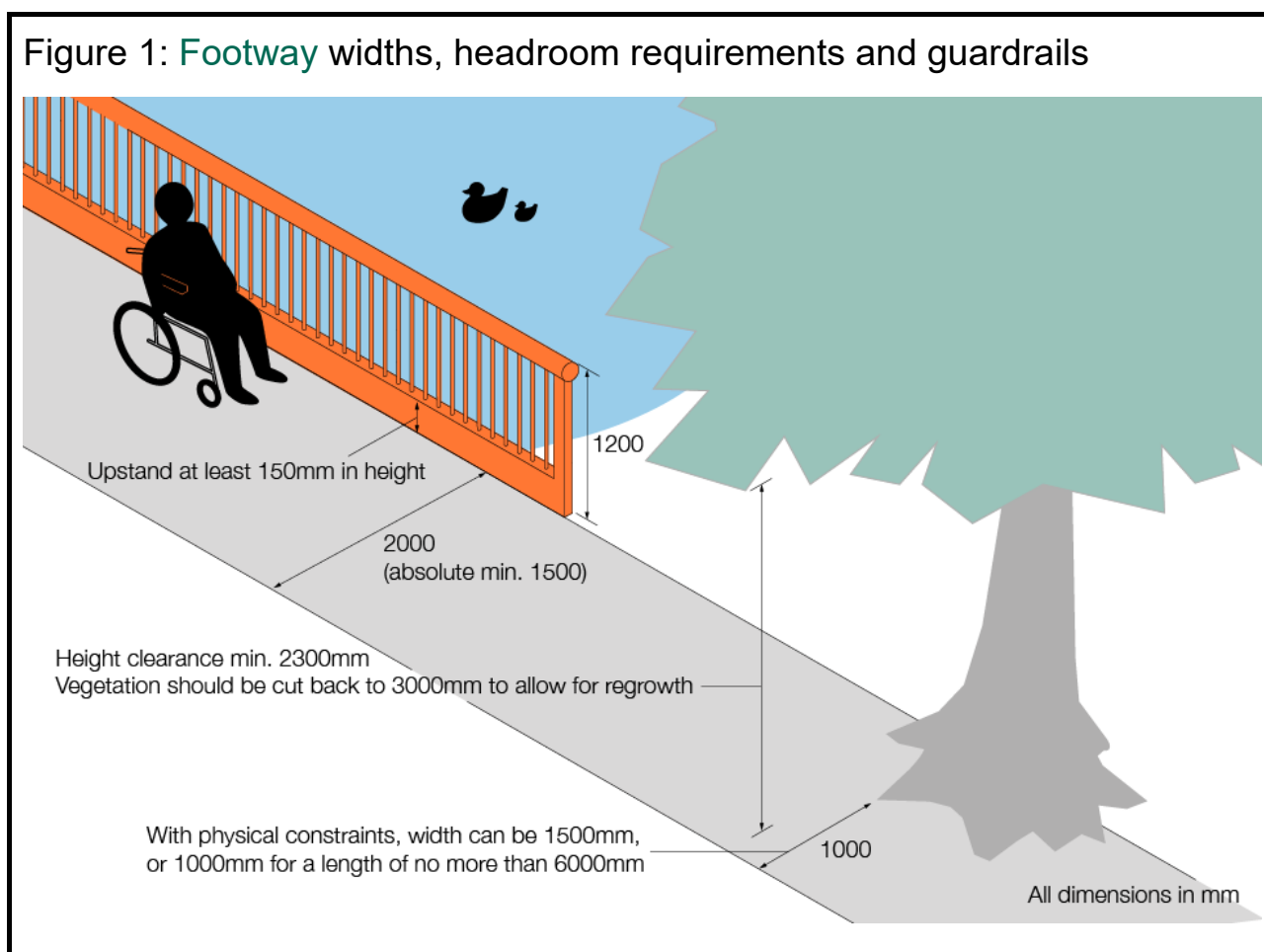

4.5 Seating

Mobility impaired people need seating at reasonably frequent intervals. In commonly used pedestrian areas, and transport interchanges and stations, seats should be provided at intervals of no more than **50 metres**. Wherever possible, seats should also be provided at bus stops and shelters. Seating should be placed adjacent to, but not obstructing, the pedestrian route and should be picked out in contrasting colours to help people with visual impairment. (The design of seating is described in Section 9.4).

4.6 Shared use routes

A shared use route is a route on which all or part of the footway has been converted to a cycle track, making it available for use by both pedestrians and cyclists. Where only part of the footway has been converted, cyclists must only use that part of the route. Mixing pedestrians and cyclists should be avoided as far as possible, in order to reduce the potential for collisions or conflict, and shared use routes in streets with high pedestrian or cyclist flows should not be used. It is particularly important to protect those pedestrians who are most at risk and who, for example, might not be able to see or hear an approaching cyclist.

Conversion of an existing footway to a shared use route should only be considered when options that reuse carriageway or other space have been rejected as unworkable. Even then, this option may only be acceptable if there is sufficient space available, with low pedestrian and cycle user numbers along the route, and low expectations that pedestrians will cross the path to access adjacent facilities, such as shops. For such cases, guidance on the accessible design of shared use routes is provided in Local Transport Note 1/20 Cycle Infrastructure Design.

Local Transport Note 1/20 is clear that shared use routes in streets with high pedestrian or cyclist flows should not be used. Where it cannot be avoided, shared use may be appropriate if well-designed and implemented and where pedestrian numbers are very low. Cycle tracks and footways should be designed to be perceived as wholly separate facilities. Where it is not possible to achieve this level of separation, and the footway and cycle track are immediately adjacent and parallel to one another, the guidance in this section should be followed. This will assist vision impaired people and will also be helpful to all other users.

4.7 Street furniture

Street furniture refers to the many and varied objects located in a typical high street, precinct or footway, including streetlights, sign-posts, traffic signs, waste bins, bollards and seating. These usually have important functions and specific purposes: for example, bollards positioned for reasons of security, or as traffic control measures, electric vehicle charge points, and sign-posts installed to provide public information.

Other items found in the pedestrian environment may have a purely commercial purpose. They include portable objects such as tables and chairs placed on footways adjacent to cafés, bars, pubs and restaurants. Free-standing advertising boards such as “A-boards” might also cause a hazard for pedestrians, particularly if their location is unpredictable and if the route around them is not clear, and can be particularly problematic for vision impaired and other pedestrians who rely on a memorised ‘map’ of their environment to navigate, for long cane users, and for guide dogs.

Whatever their purpose, objects on routes used by pedestrians can present an obstacle and hazard, particularly wheelchair users and vision impaired people.

Street furniture should be positioned to leave at least the minimum width recommended for a pedestrian footway (Section 4.2). Streetlights and signs should be mounted on buildings or walls wherever possible; if not, then placing them at the back of the footway as near the property line as possible is acceptable

It will help vision impaired people, in particular, if the positioning of posts and other freestanding items on the footway is consistent. Such consistency will be helpful for all pedestrians. It is also preferred that such objects be placed as near to the building line as possible: for post-mounted street furniture, the distance from the property line to the outer edge of the post should be a maximum of **275mm**. Where a footway is adjacent to a road used by motor vehicles, any post placed on the road-side of the footway should be at least **450mm** from the edge of the road. This distance should be at least **600mm** where there is a severe camber or crossfall. If there is more than one post, they should be at least **1000mm** apart.

Waste bins should be approximately **1300mm** in height and continue down, or close to, the ground, and they should have a generally rounded design, with rounded edges and no sharp or protruding elements. For waste bins not open at the top, the opening should be **750mm** to **900mm** from the ground.

As a general design principle, any item of street furniture should be tonally and colour contrasted with its environment in order to make it as conspicuous as possible. Consideration should be given to choosing a finish that enables an object to be easily seen in its environment. For that reason brushed metal finishes should be avoided. Posts should, where permitted, have a band

applied that tonally and colour contrasts with the environment. This band should be approximately **150mm** in depth with its lower edge approximately **1500mm** from the ground.

Bollards, if necessary, should have tonal and colour contrasted tops. The incorporation of a light at the top of bollards is also an effective way of making them more easily seen.

Bollards and other freestanding objects, such as raised flowerbeds, should be at least **1000mm** in height. Bollards should not be connected with a chain or a rope, as this might present a trip hazard, particularly for people who are vision impaired.

Bollards might be used as a Vehicle Security Barrier (VSB) to mitigate criminal or vehicle-borne threats and might be used at busy transport stations and interchanges. In such cases, the installation of bollards should provide an appropriate level of physical protection whilst minimising any negative impact on pedestrian movement. Gaps between bollards should be a maximum of **1200mm**. Detailed guidance on the placing of VSB bollards is provided in Traffic Advisory Leaflet TAL 2/13.

Low-level signs supported on two vertical poles (e.g. city maps) should have a tapping rail or skirting, with a depth of at least **150mm** and a lower edge that is no more than **200mm** from the ground, to prevent vision impaired people from inadvertently walking between them and colliding with the sign. The sign itself should not extend by more than **150mm** beyond the supporting posts.

Any sign suspended above a pedestrian footway should leave a minimum clearance of **2100mm** from the ground. On sub-surface station platforms, however, there should be a minimum clearance of **3000mm** from the ground (Section 4.2).

Temporary structures such as street market stalls and pavement café tables should be placed so as to leave clear pedestrian routes. Consideration could be given to using colours (or textures) to help people detect between where obstacles are allowed and the clear path through the development.

A pavement licence is a licence granted by the local authority which allows the licence-holder to place removable furniture over certain highways

adjacent to the premises in relation to which the application was made, for certain purposes. All licences are subject to a no-obstruction condition, that anything done by the licence holder must not, amongst other things, prevent non-vehicular traffic passing along the relevant highway, this would include disabled people. Local authorities can also publish local conditions including on accessibility, which applications will need to adhere to. When they grant a licence, local authorities may impose reasonable conditions whether or not they are published upfront. There is an expectation that these will be supported by a clear justification for the need of a condition, such as evidence raised during the consultation, which is in addition to any published local conditions. Conditions might, for example, limit the maximum number of chairs and tables, or type of furniture, time and days of operation, with justification for this. When setting conditions, determining applications (in the absence of local conditions) and when considering whether enforcement action is required, authorities should consider Section 3.2 of this guidance, where in most circumstances **1500mm** clear space should be regarded as the minimum acceptable distance between the obstacle and the edge of the footway.

Any obstruction that projects into a route used by pedestrians by more than **100mm** - in a vertical zone between **300mm** and **2100mm** from the ground - should have hazard protection applied to it. However, no hazard protection is required if the base of the obstruction is less than 300mm above ground level. Such protection should take the form of a barrier at a height of **1000mm** from the ground (between **900mm** and **1100mm**), with a kerb or tapping rail at ground level, positioned no more than **100mm** behind the front edge of the obstruction. The tapping rail should have a depth of at least **150mm** and its lower edge should be no more than **200mm** from the ground.

Figure 2: Low-level obstructions

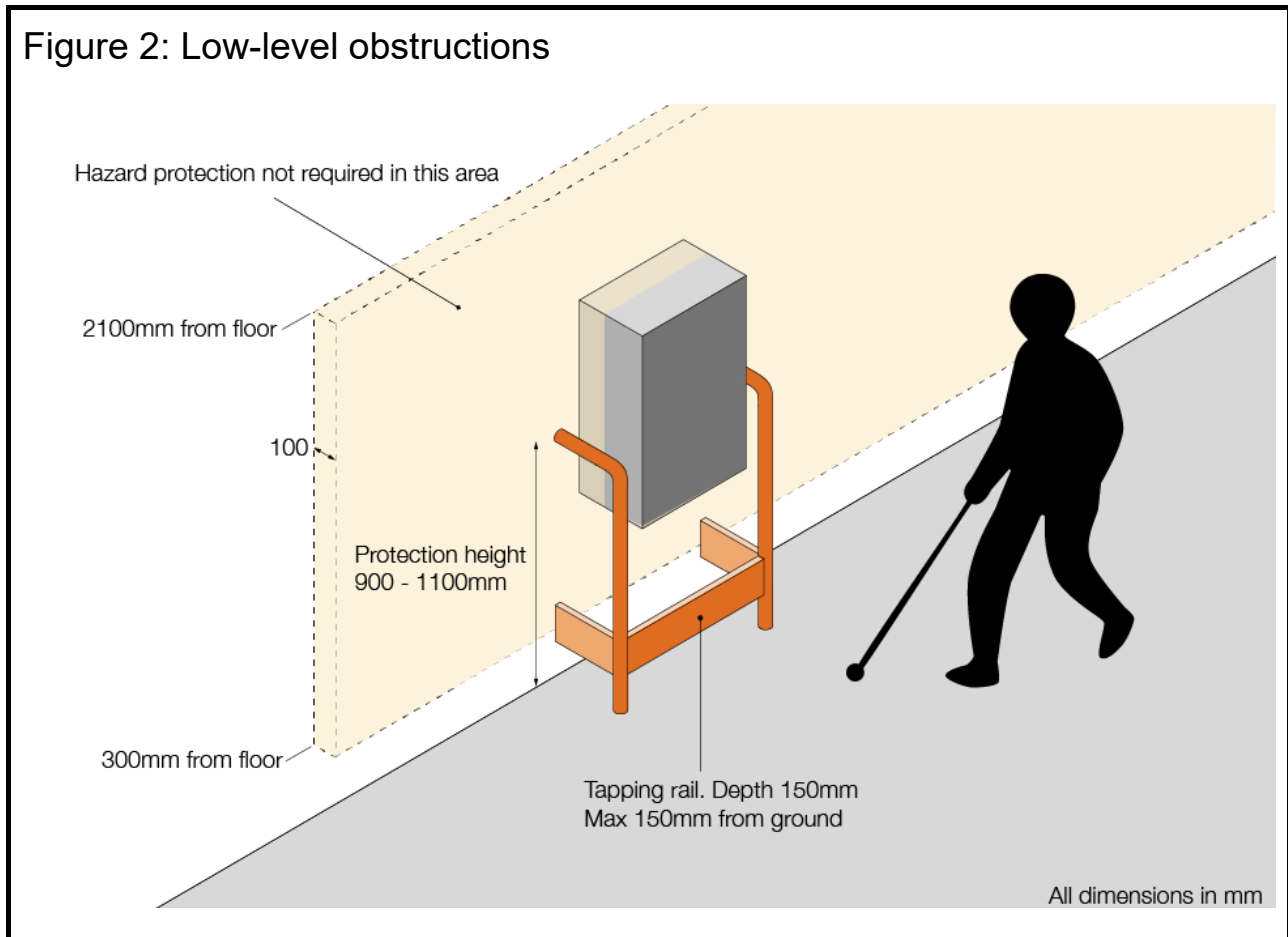

Random obstructions such as rubbish bags, ladders, vegetation encroaching on the footway and cycles parked on the pavement, present additional hazards. Such obstructions can be avoided through the drafting and application of appropriate policies and procedures. Similarly, parking of cars either wholly or partially on the footway is another common hazard for pedestrians which is prohibited in places by legislation. Local authorities in England have powers to ban pavement parking through the use of Traffic Regulation Orders and traffic signs. A specific “No pavement parking” sign is available for local authorities to use: more information on the use of these signs is available in Chapter 3 of the Traffic Signs Manual.

4.8 Surface materials and maintenance

Uneven surfaces and gaps between paving slabs etc. can cause problems for some people, including those using sticks and crutches, people who are

vision impaired and wheelchair users. Joints between flags and pavers should be not less than **2mm**, and not more than **5mm**, wide. For pedestrian-only footways, joints between flags filled with compacted mortar may be wider (**6-10mm**). The maximum deviation of the footway surface under a 1 metre straight edge should not exceed **3mm**. New cobbled surfaces are unlikely to be appropriate and, even in historic environments, alternatives should be sought.

Covers and gratings can also cause problems and may be mistaken by vision impaired people for a tactile surface. It is recommended that the size of openings should not exceed **13mm** and if openings are elongated they should be placed at right angles to the predominant direction of travel. These spaces should not be more than **150mm** long. Wherever possible, gully covers and drainage slots should be positioned as far as possible from main pedestrian flows. Inspection chamber covers and service inspection chambers should be flush with the surface.

Surfaces should be firm and slip-resistant in wet and dry conditions and should not be made of reflective material. Dished channels (for drainage) should not be incorporated within the main pedestrian flow. When small paving bricks (paviours) are used, care should be taken to ensure that they are evenly laid; any unevenness can cause problems for some people, including wheelchair users and cane users.

4.9 Street works and other potential hazards

Street works should be managed so that they are properly safeguarded to avoid hazards and obstruction to pedestrians. Street works, including their materials and equipment, should be guarded around their full extent by a continuous barrier. The height of this barrier should be a minimum of **1000mm** and a maximum of **1200mm** and have a tapping rail beneath it. These barriers should be robust and placed so that they cannot be knocked over should a pedestrian collide with them. They should have a tonal and colour contrast with their surroundings, and preferably with colours such as red used in part to indicate the proximity of a potential hazard. Illumination of street works at night will also help pedestrians, particularly those who are vision impaired.

Figure 3: Street works protection

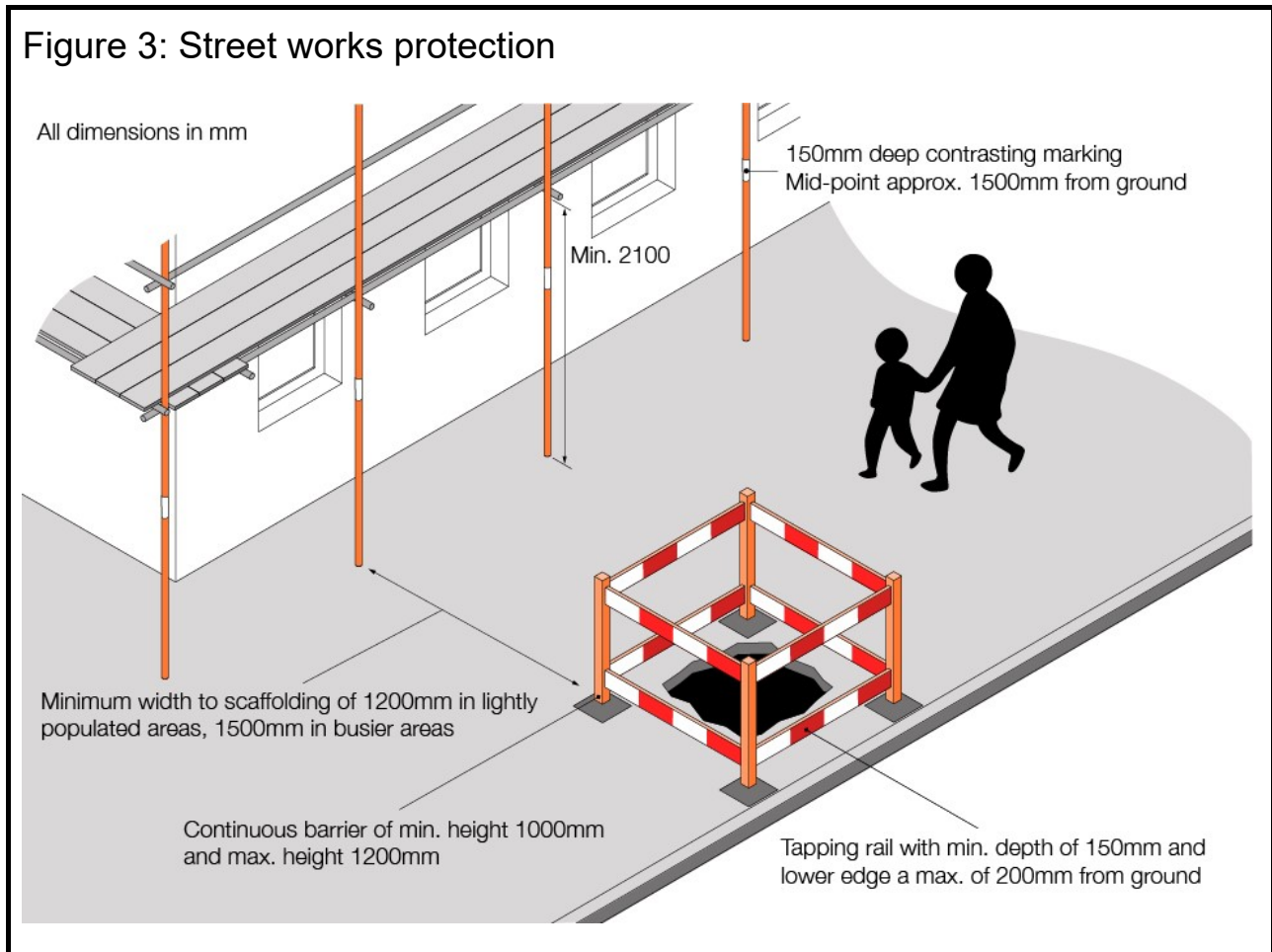

Any signs placed on the footway related to the works should be positioned so that they minimise inconvenience and potential for hazard, especially for those who are vision impaired, wheelchair and mobility aid users and anyone with a pushchair, pram or buggy. The lower edge of any such sign should be no less than **300mm** from ground level.

If works are being carried out on a footway and a walkway in the carriageway is provided because it is not possible to maintain safe pedestrian access on the footway and a safe off-carriageway alternative cannot be found, suitable barriers should be erected to protect pedestrians from traffic and other hazards. The route provided should have a minimum width of **1200mm**, and an absolute minimum width, unobstructed by, for example, barrier bases or feet, of **1000mm**. Kerb ramps or a raised temporary footway should be installed to assist wheelchair users and others. These should be strong enough to support a mobility scooter and be slip-resistant. The route must be

properly drained, with adequate headroom, reasonably smooth and without steep gradients or crossfalls. Further guidance is provided in *Safety at Street Works and Road Works: A Code of Practice*.

Where scaffolding is erected on or over a footway, there must be adequate height clearance (**2100mm minimum**) and an absolute minimum footway width of **1200mm** in lightly populated areas, **1500mm** in busier areas. The safest measure for all members of the public is completely enclosing the works with a hoarding. Hoardings should be marked with a tonally and colour contrasting band with a depth of approximately **150mm**, and a lower edge approximately **1500mm** from the ground. Appropriate lighting and signing should also be installed.

If temporary obstructions have to be placed on a pedestrian route, such as an area used for redecorating a shop front or using a ladder, the obstruction should be clearly marked using tonally and colour contrasting tape, or a similar means of making the object conspicuous, and pedestrians should be directed around the obstruction. In addition, the minimum footway widths of 1200mm in lightly populated areas and 1500mm in busier areas should be maintained.

Building and street works within bus and rail stations, interchanges and other transport facilities used by the public should also be guarded in a manner similar to that described above.

4.10 Road crossings

Mandatory requirements for all types of controlled crossing are set out in the *Traffic Signs Regulations and General Directions (TSRGD) 2016* (as amended). This includes the definitions of different crossing types, and the signs, signals and road markings required to create each type. Detailed guidance on the traffic control aspects of the design of road crossings is contained in Chapter 6 of the *Traffic Signs Manual*, which gives guidance on the use of traffic signs and road markings prescribed by *TSRGD (2016)*. The *Traffic Signs Manual* includes advice on crossings and how to conduct an assessment into whether a controlled crossing is needed in a given location or, where a crossing already exists, whether it should be changed to a different type.

The Traffic Signs Manual gives definitions for both uncontrolled crossings, which might simply provide a pedestrian refuge or a dropped kerb, and controlled crossings. The latter consist of give-way crossings and signal-controlled crossings.

Give-way crossings:

- zebra crossings, where drivers must give way to any pedestrian on the crossing
- parallel crossings, consisting of parallel routes for pedestrians and cyclists. Drivers must give way to any cyclist or pedestrian on the crossing.

Signal-controlled crossings:

- toucan crossings, which allow both pedestrians and cyclists to cross at the same time
- pedex (signal-controlled) crossings, which are standalone crossings that use far-side signals
- puffin crossings, which use near-side pedestrian demand units
- equestrian crossings, which allow horses and their rider to cross the carriageway

There are three criteria that should be used when assessing what type of crossing is most appropriate: safety, convenience and accessibility. A crossing that does not improve on all three to some degree is unlikely to be satisfactory, and consideration of these criteria will form an important part of the assessment process.

Without a traffic control mechanism, pedestrians' ability to cross a road depends on the volume and speed of the vehicles, and of the behaviour of vehicle users, using that road. Controlled crossings can be particularly important to disabled people, older people and other more vulnerable road users at higher risk, so the assessment should consider their needs.

A suggested assessment process is provided in Chapter 6 of the Traffic Signs Manual of including checks of the geometry of the road involved, a series of

site inspections that eliminate any daily or seasonal effects, and surveys of both vehicular traffic and pedestrian flows. The latter survey should observe the number of vision impaired people crossing a road in a given location, as well as the number of people with a physical condition that affects their mobility, plus older people, children and people with a pushchair, pram or buggy.

Practitioners carrying out assessments should be aware that any data relating to the number of disabled people using a road are likely to be an underestimate, given the likelihood that some pedestrians observed will have a non-visible impairment. Furthermore, such survey data will certainly underestimate the level of demand for a controlled crossing because of suppressed demand: it is likely that many vulnerable road users who would benefit from, and use, a controlled crossing may be absent from the location being surveyed, simply because they feel unsafe crossing the road at that location. To provide a more accurate appraisal of the level of demand for crossing control, and its impact on accessibility, it is essential for effective engagement with local accessibility groups to be part of the assessment, from the outset.

Puffin Crossings include pedestrian demand units, which consist of a push button summoning a red light for vehicular traffic and a display unit showing pedestrians a 'Red Standing Symbol' and 'Green Walking Symbol', respectively. The pedestrian demand unit should be installed so that its bottom edge is between **1000mm** and **1100mm** from the ground. A raised, large diameter push button, that can be activated by a closed fist, will be convenient for most pedestrians. It should also have an illuminated LED surround and/or be tonally and colour contrasted with the box to maximise its visibility.

TSRGD (2016) advises that the pedestrian demand unit should be installed between the area where pedestrians are waiting and the nearest approaching traffic. This is to encourage people to observe approaching vehicles. This usually means that the unit is installed to the right of pedestrians. Where positioning the unit to the left is unavoidable, it should be accompanied by a push button on the right of the crossing – this is compatible with the training of guide dogs to guide a person from the left. A button on each side of the crossing should also be provided at Puffin Crossings that are wider than the standard 2400mm width, and also at central refuges where the road consists of a two-way carriageway. The rationale for the latter is that this will encourage sighted pedestrians to face on-coming vehicles, while also

positioning a button in a location where vision impaired people will expect to find it. Both pedestrian control units and push buttons should be positioned **500mm** from the line of crossing studs, to ensure that they can be reached and operated by a pedestrian standing on the crossing's tactile paving surface.

Toucan Crossings enable pedestrians and cyclists to cross a road at the same time. If such a crossing is approached by a segregated **footway** and cycle track, this separation should come to an end in advance of the crossing waiting area. There should also be tactile paving surfaces provided with the required colours and layout, in accordance with the Department for Transport's publication *Guidance on the Use of Tactile Paving Surfaces*.

For a Toucan Crossing the minimum width is **3000mm**, although some more vulnerable pedestrians might feel uneasy when sharing a crowded waiting area with cyclists, so a width of **4000mm** is preferred. For all Toucan Crossings, a push button should be provided on each side of the crossing. The height of push buttons for users such as recumbent cyclists and people using adapted cycles should be considered.

Equestrian crossings allow horses and their rider to cross the carriageway and may help reduce the risk of collisions. Where a bridleway crosses a road where the visibility is adequate and vehicular flows and 85th percentile speeds are reasonable, an uncontrolled crossing place may be suitable, particularly if the bridleway has a good surface and there is space for all users to wait in safety. TSRGD (2016) prescribes both far-side and near-side forms of pedestrian demand unit, and also prescribes road markings for such crossings.

New Pelican Crossings are no longer prescribed for installation in England, Scotland or Wales, although existing Pelican Crossings can be retained until the end of the life of their equipment.

Tactile and audible signals at controlled crossings, which convey the same information as the 'Green Walking Symbol', are particularly useful for vision impaired people, but also help other pedestrians. Tactile signals, in the form of a rotating cone, are especially helpful to people with dual sensory loss and should be provided at controlled signal crossings as a default.

Technical requirements for the design of the cone are given in TOPAS specification TOPAS 2508C: Performance Specification for Tactile Equipment for Use at Pedestrian Crossings. The Department recommends that traffic authorities purchase equipment that is TOPAS registered. This includes signal heads, pedestrian demand units and audible and tactile signals. More information is available at <http://www.topasgroup.org.uk/>.

Where centre refuge islands are provided at a crossing, they must be a minimum of **1500mm** in width to be able to cater for wheelchair users, but preferably **2000mm** in width. If the island is at the centre of a staggered crossing, the clear space between guardrails must be a minimum of **2000mm** (Section 4.2).

If street works mean that a pedestrian crossing cannot be used, the following procedure should be followed:

- install barriers to prevent pedestrian access to the crossing
- erect signs on both sides of the road to make it clear that the crossing is not in use
- extinguish any lights on pedestrian demand units or push button boxes, or that illuminate yellow globes at Zebra Crossings

For planned street works, it would be good practice for local authorities to alert local accessibility groups so they can help to disseminate the news to local people who might be affected.

4.11 Dropped kerbs and raised crossings

Level access at all road crossings is essential, particularly for wheelchair users, whether by a dropped kerb or a raised crossing. The Traffic Signs Manual states that flush dropped kerbs, with the appropriate tactile paving surface, should always be provided at crossings to provide easy access for mobility impaired people. On longer side roads and residential roads, consideration should be given to the provision of dropped kerbs at least every **100 metres**, where possible, to avoid the need for pedestrians, particularly wheelchair users, to make lengthy detours to cross the road. Due consideration must be given to pedestrian desire lines. Where such an at-

grade crossing point is provided, it should be accompanied by the appropriate tactile paving surface, for the safety of vision impaired pedestrians (see Guidance on the Use of Tactile Paving Surfaces).

Dropped kerbs should preferably be flush with the road, but with a maximum **6mm** tolerance if not, provided that a rounded bullnose is provided at the change of level. It is important that ramps are designed appropriately: the maximum gradient on the direct approach to the dropped kerb, the gradient should not exceed **1 in 12**, and where space allows, a gradient of 1:20 should be achieved; for the transitions to a dropped kerb, the gradient should not exceed **1 in 11**. The flush portion of the dropped kerb should have a minimum width of **1200mm**, but the minimum width should be **3000mm** where there are heavy pedestrian flows. In the specific case of a dropped kerb adjacent to car parking spaces for disabled users, a flush area **1000mm** wide is acceptable. Where a dropped kerb is provided at a controlled road crossing, it should be the same width as the crossing itself (i.e. a minimum width of **2400mm**). Care should be taken to prevent a wheelchair's front wheels or footrests catching on an opposing upslope. For this reason, at the foot of a dropped kerb, the camber of the road should be no more than **1 in 20**, for a distance of 600mm from the kerb line, which approximates a wheeled mobility aid's wheelbase.

Where a dropped kerb is provided, there should preferably be a level space of at least **900mm** to its rear, to allow easy passage for wheelchair users who are not crossing the road.

For the safety of vision impaired pedestrians, a dropped kerb should not be installed within the radius of an uncontrolled road junction, regardless of the availability of tactile paving surfaces. Where the radius is large, and there is no reasonable alternative to locating the dropped kerb within it, the dropped kerb should be as close as possible to the right-angled crossing of the side road (see Guidance on the Use of Tactile Paving Surfaces).

An advisory 'H bar marking' should be applied at a dropped crossing to inform drivers that the space should be kept clear for access (see TSRGD (2016)).

For raised crossings, the raised area should be at least **2400mm** in width and level with the footway (see Guidance on the Use of Tactile Paving Surfaces).

5. Changes in level

5.1 Steps and stairs

Although some people might prefer using a step to a ramp, the provision of steps in response to a change in level has obvious potential for presenting an obstacle for wheeled mobility aid users and people who have a mobility impairment. Some individuals, who can manage steps, may still experience pain or discomfort when using them, particularly if the rise of each step is too high. For people who cannot use steps, an alternative, such as a lift or a ramp, should be provided.

As well as being a potential obstacle, a single step can be a trip hazard and a flight of steps can present a considerable danger for any pedestrian, but particularly for vision impaired people. For this reason, warning must be given to pedestrians that they are approaching a flight of steps, both at the top and bottom of the flight, in the form of the appropriate tactile paving surface. At the bottom of a flight of steps, there should be a **400mm** gap between the tactile paving surface and the bottom of the first step. Details of the type of surface to be used, and its application, can be found in *Guidance on the Use of Tactile Paving Surfaces*.

There should also be an unobstructed landing space, at the top and bottom of each flight of steps, with a length at least equal to the unobstructed width of the steps. Each flight of steps should consist of a maximum of **12 steps** and a minimum of **3 steps**, and there should be a resting place, or 'landing', between successive flights. Each landing should be at least **1800mm** in length (**1200mm** minimum) and have a width matching the width of the stairway.

To minimise the possibility of tripping, each step in a flight must be identical in terms of its height and depth, and not be tapered. A considerable amount of research on dimensions and design of steps and stairs was carried out in the 1970s and 1980s and there is reasonable consistency between the dimensions given in various national guidelines. A riser height of **150mm** can be managed by most people; a little more than this is possible if there are well

designed handrails, but **170mm** should be regarded as the maximum in normal circumstances. Each step should have a depth of **300mm** (approximately the length of a size 9 shoe), with an absolute minimum of 250mm.

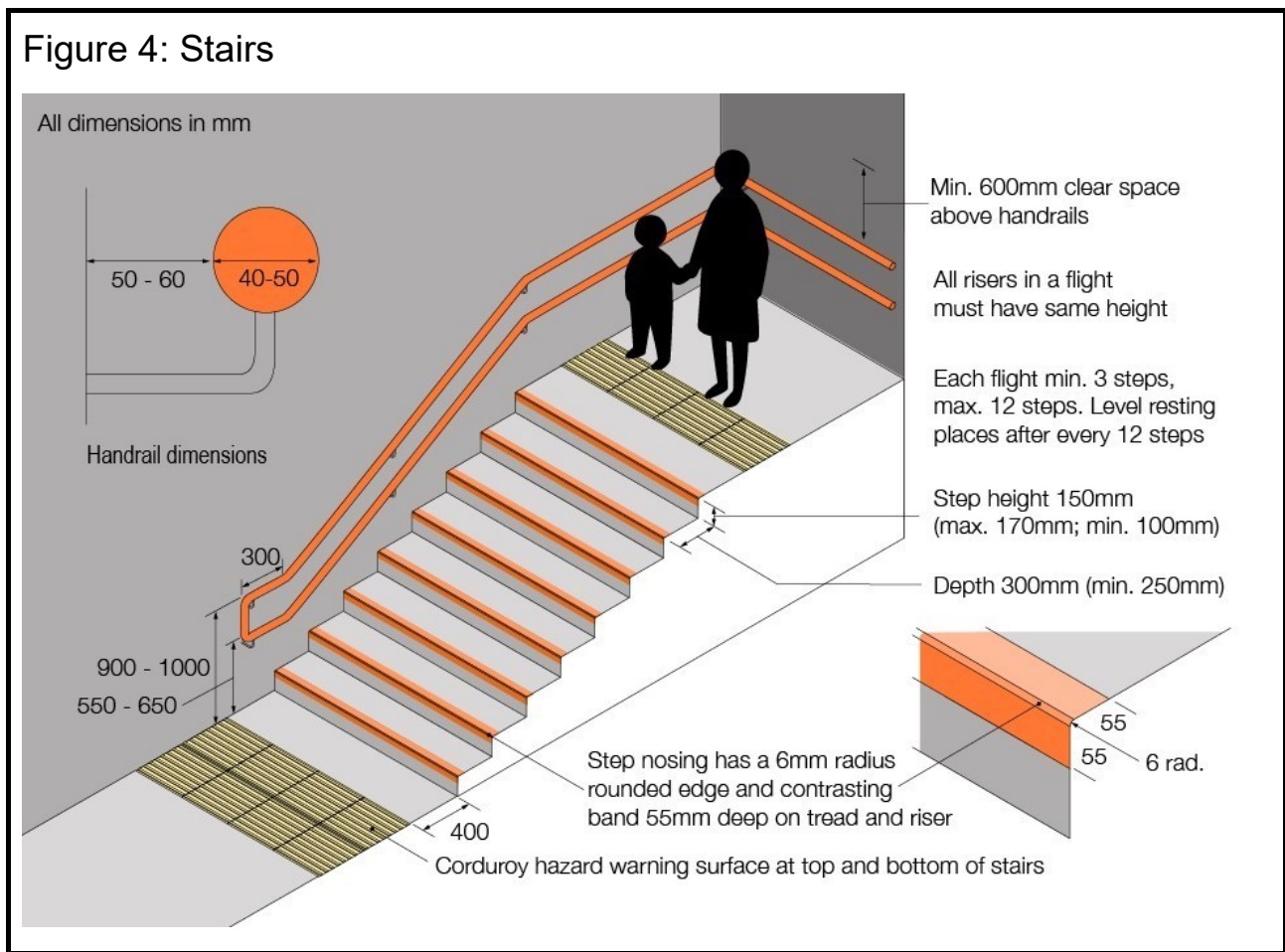

The nosing of each step should be rounded, with a **6mm** radius, with no overhang. The absence of an overhang is to prevent people who have a mobility impairment from catching their foot. It is essential for each step nosing to be tonally and colour contrasted, and so an appropriately contrasting band **55mm** deep should be applied on both the tread and the riser and extend across the full width of each step. IP 15/03 Proprietary Nosings for Non-domestic Stairs (BRE, 2003) provides design guidance on the type of proprietary nosings that should be used on non-domestic stairs.

Curved or spiral staircases should be avoided. Flights of steps with open treads should also be avoided.

Stairs should have a minimum clear width between handrails of **1200mm**, which is sufficient for a disabled person and companion. A handrail beside a flight of steps can be helpful for many people and where handrails are provided it is preferable that there should be one each side (Section 5.3). Where stairways have a clear width of more than 1800mm, a centre handrail should be provided. Stairs of this width are needed where there is concurrent, two-way movement. Flights of steps that lead to a platform, on which people might be carrying luggage and moving in multiple directions, should be at least **3000mm** wide and have a centre handrail.

Steps should be well lit (a minimum of **200 lux**, see Section 14) and be surfaced with a slip-resistant material.

5.2 Ramps

A ramp (defined as a gradient of more than 1 in 20) can provide an alternative to steps. Where the change in level is no more than **200mm**, a ramp may be used without alternative steps.

A ramp should have the lowest practicable gradient. 1 in 20 is the preferred gradient and 1 in 12 is the absolute maximum acceptable.

BS 8300-2 explains that the preferred gradient should only be used up to a maximum length of **3000mm**, and that the maximum gradient of 1 in 12 should only be used to a maximum length of **2000mm**. It also provides detailed guidance on the relationship between the going, gradient and rise of ramps.

There is a relationship between the length of a ramp and the gradient that people can manage; the longer the ramp the less severe the gradient that is feasible. If a lengthy ramp is necessary, designs with frequent landings and lesser slopes for each successive segment should be considered.

A slightly steeper gradient of **1 in 10** is acceptable over very short distances, for example a ramp covering a distance of **600mm**. Gradients steeper than 1 in 10 are physically difficult to manage for some wheelchair users, and may cause a wheelchair to overbalance.

If more than one flight is needed, there must be rest places between the flights. These should be level if under cover (**1 in 50** gradient if outside, to drain surface water) and their length should be at least **1500mm** and at least equal to the full width of the ramp. The landings at the foot and head of a ramp should be at least **1200mm** long, clear of any obstruction such as door swing and, again, should be the full width of the ramp. Each individual flight of a ramp should have a length of no more than **10 metres** and a rise of no more than **500mm**.

Ramps in locations subject to control under the Building Regulations and similar will need to satisfy the requirements of that legislation.

Ramps should have a minimum surface width of **1500mm**, but, as with flights of steps, a ramp on which there is a two-way movement of pedestrians should preferably have a width of at least **2000mm** (with a minimum of **1800mm**).

A handrail should be provided on each side of the ramp. For ramps with a clear width of at least **2000mm**, an additional continuous handrail should be installed in between the two, such that there should be a minimum clear width between handrails of at least **1000mm**. The sides of a ramp should be protected by an upstand that is at least **100mm** in height.

Figure 5: Ramps

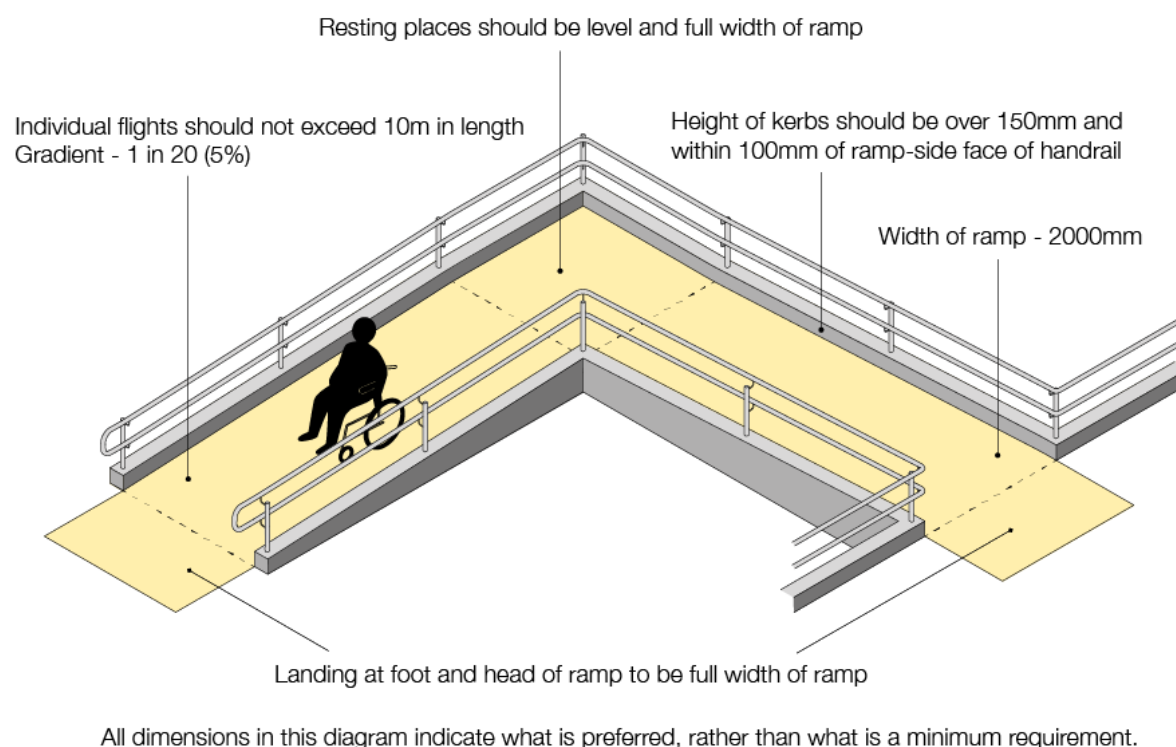

The transition between level and inclined parts of a ramp should be sufficiently rounded to ensure that wheelchair user's foot supports do not catch on the surface.

There is rarely a need for a crossfall on a ramp. If drainage is likely to be a problem, then a permeable surface should be considered. Ramp surfaces must be slip-resistant and non-reflective.

If portable or temporary ramps are needed, to give access to an existing building, they should be positioned, and their presence identified, so that they do not constitute a hazard to passers-by. These ramps should have a surface width of at least **800mm** and a drainable, slip-resistant surface, with upstands to prevent wheelchair users from veering off the edge.

5.3 Handrails

The top of the principal handrail should be at a height of between **900mm** and **1000mm** above the pitch line of steps, or above the surface of a ramp. On landings, the top of the handrail should be at a height of between **900mm** and **1100mm** from the surface. Handrails should continue beyond the end of the sloping part of the ramp, or stairs, by at least **300mm**, and return either to the wall or the floor, or have a minimum rounded downturn of **100mm**.

A second, lower handrail can be useful for some people, and this should be positioned at a height of between **550mm** and **650mm**.

The handrails should be smooth, and not too small in diameter, so that they are comfortable to use by people with arthritic hands. Circular cross section handrails should have a diameter of between **40mm** and **50mm**; handrails that are not circular should be a maximum of **50mm** wide by **38mm** deep and have rounded edges (with a radius of at least **15mm**).

There should be a clear space preferably of **60mm** (minimum **50mm**) between the handrail and any adjacent wall. Handrails should be supported centrally on their underside, to allow the unimpeded passage of hands along the rail. There should also be a minimum of **600mm** clear space above the handrail.

It is essential for handrails to be tonally and colour contrasted with their background.

5.4 Escalators

It should be borne in mind that escalators are difficult for some people to use and cannot be used by wheelchair users and some assistance dog users. Therefore, generally, where there are substantial changes in level, a lift should be provided.

Where escalators must be used, the maximum speed recommended for escalators is **0.75m/s**, and a slower speed (perhaps down to **0.5m/s**) may be preferable where levels of passenger use are lower. The recommended angle of inclination should be between **30°** and **35°**.

The width of the escalator should be a minimum of **580mm** and a maximum of **1100mm**, and steps should be a maximum height of **240mm**; note, this maximum should be reduced to **210mm** if the escalator is also intended to be used as an emergency exit when stationary. There should be a minimum vertical clear height above the escalator of **2300mm**.

The surface of the escalator's steps should be matt, having a non-reflective finish. The moving handhold should be at a height of between **900mm** and **1100mm** above the step nosing and, as with handrails on stairs, extend by at least **300mm** beyond the ends of the escalator. The handhold should be tonally and colour contrasted with its environment and move synchronously with the escalator. The edge of each step should also be tonally and colour contrasting, with a **55mm** deep band on the tread of the step only.

For escalators used in heavily trafficked places, there should be a clear space on the approach to an escalator of at least **10 metres**. The direction of travel should be clearly indicated at the top and bottom of the escalator. Its steps should form a level area of at least **2000mm** at the top of the escalator and at least **1600mm** at the bottom. This is important, since falls involving escalators most often happen when people are boarding or leaving an escalator. An audible warning at the beginning, and just before the end, of the escalator is essential for vision impaired people. Good lighting is also important and should be a minimum of **50 lux**. There should also be a noticeable change in lighting at the bottom and top of the escalator.

5.5 Travelators / Moving walkways

Where there are substantial distances to be traversed within terminals, travelators (or moving walkways) help many people, but they should always have a parallel walkway. For some people, particularly older people who are a little unsteady, stepping onto a moving walkway is not a comfortable experience.

Where travelators are provided, the direction of travel should be shown clearly and the footway at both ends should be marked by tonal and colour contrast and a change in floor finish. The travelator must be well, and evenly, lit, particularly at its entrance and exit. The moving handrails should be rounded in section and tonally and colour contrasted with the background. Handrails should extend approximately **700mm** beyond the beginning of the walkway. The recommended width for a travelator is **1500mm**, with a minimum height clearance of **2300mm**. There should be a minimum level and unobstructed run-off at each end of **6000mm** and there should be an audible warning both at its beginning, and prior to its end; this is essential for people who are vision impaired. A travelator should have a maximum gradient of **1 in 20**.

The side panels of the travelator channel should be finished in a non-reflective surface; back illuminated side panels can be very disorientating. Its surface should be slip-resistant.

The speed of movement of the travelator should be kept low: **0.5m/s** is recommended (**0.75m/s** maximum). There should be clearly visible emergency stop switches that can be reached and operated by any pedestrian, regardless of their level of ability. An audible warning at the beginning and prior to the end of the travelator is essential for vision impaired people.

5.6 Lifts

Where there is a substantial change in level, lifts are essential for wheelchair users, and for some people who have a mobility impairment. They should also be provided in preference to very long ramps. To ensure that they are easy to find, the location of lifts should be clearly signposted from the main pedestrian route and be easily recognisable through their design and location.

The lift doors should have a clear tonal and colour contrast with the surrounding wall; a clear contrast between the lift's internal walls and floor will further assist vision impaired people.

To ensure that there is enough room for a wheelchair user to manoeuvre into place and wait without obstructing the passage of other people, there should be a minimum clear space of **1500mm x 1500mm** outside the lift. If this area of clear space is finished in a different colour from the surrounding floor, it will help vision impaired people locate the lift entrance. Visual and audible announcements should be provided both inside and outside the lift, with a sound level of between **30** and **55dBA**, adjustable according to ambient conditions. An audible signal on the landing should indicate when the doors are opening. An illuminated indicator arrow giving an advance indication on the direction the lift is going should be placed above, or near, the doors in a visible position. The indicator arrow should have a height of at least **40mm**. It is also recommended that a **5 second** notification should be given that the lift is answering a landing call.

The lift door opening should have a clear width of at least **900mm**, to allow for wheelchair users' elbow space, and a height clearance of at least **2100mm**. Inside the lift, there should be a minimum height clearance of **2300mm**. The lift doors should stay open for long enough to allow people who move more slowly to get in and out of the lift without being caught by the doors. A minimum dwell time of **5 seconds** before the doors begin to close after they are fully open is preferred, but **3 seconds** is acceptable. The control system should allow for door dwell time to be adjustable, up to **20 seconds**, but the means of adjustment should not be available to users.

Lift doors should have a non-contact 'curtain of light' detection mechanism to prevent them from closing should an obstruction be detected. This is to reduce the risk of the doors striking passengers while they are entering or exiting the lift car. Further details are available in British Standards BS EN 81-20:2020 (Safety rules for the construction and installation of lifts. Lifts for the transport of persons and goods. Passenger and goods passenger lifts) and BS EN 81-70:2021 (Safety rules for the construction and installation of lifts. Particular applications for passenger and goods passenger lift. Accessibility to lifts for persons including persons with disability).

Ideally, the internal dimensions of a lift should be sufficient to enable a wheelchair user to turn round and exit facing forwards. Minimum dimensions are recommended in the following table.

Type of lift	Minimum car dimensions	Accessibility level	Remarks
1	1000mm wide x 1250mm deep	This lift car accommodates one wheelchair user	Provides access for manual and powered wheelchairs used in indoor environments
2	1100mm wide x 1400mm deep	This lift car accommodates one wheelchair user and one accompanying person	Provides access for manual wheelchairs and powered wheelchairs that are capable of negotiating some outdoor obstacles
3	2000mm wide x 1400mm deep	This lift car accommodates one wheelchair user and several other passengers. It also allows a wheelchair to be rotated	Provides access for manual wheelchairs and powered wheelchairs that are used outdoors. The car provides sufficient turning space for users of Class A and B wheelchairs or walking aids (walking frames, roller frames, etc.)

Minimum car dimensions for lifts with a single entrance or two opposite entrances.

It should be re-emphasised that the recommendations contained in the above table are minimum dimensions, and that a depth of **1500mm** is preferred; this extra depth will make it easier for wheelchair users to turn and will also benefit someone with an elevated leg rest, for example. Where it is possible to install them, walk through lifts with doors on opposite sides are preferable to single door lifts.

Placing a mirror on the rear wall of the lift will enable wheelchair users to see a floor indicator located over the entrance. In lifts where a wheelchair user cannot turn around, a mirror or other device should be installed inside the lift to enable them to observe obstacles when exiting the lift backwards. Where wall mirrors are installed, care should be taken to avoid creating optical confusion for vision impaired people. Where glass is used on walls, it must be safety glass, but in general it is preferred that internal walls should have a non-reflective, matt finish. Lift floors should have a slip-resistant finish. Any decorative finishes on the wall of the lift must not exceed **15mm** in thickness.

Interior lighting should provide a level of illumination of at least **100 lux** at floor level and be uniformly distributed. The use of spotlights and downlighters should be avoided.

Many people might appreciate having a tip-up seat in the lift. If such a seat is provided, it should not impede the normal use of the lift, and not encroach on the minimum dimensions quoted above, when in its folded position. Any such seat should have a height of **500mm ± 20mm** from the lift floor, a depth of **300 to 400mm** and a width of **400 to 500mm**. The seat should also be designed with a maximum weight capacity of **100 kg** and be tonally and colour contrasted with the lift's interior décor.

Figure 6: Lift interior

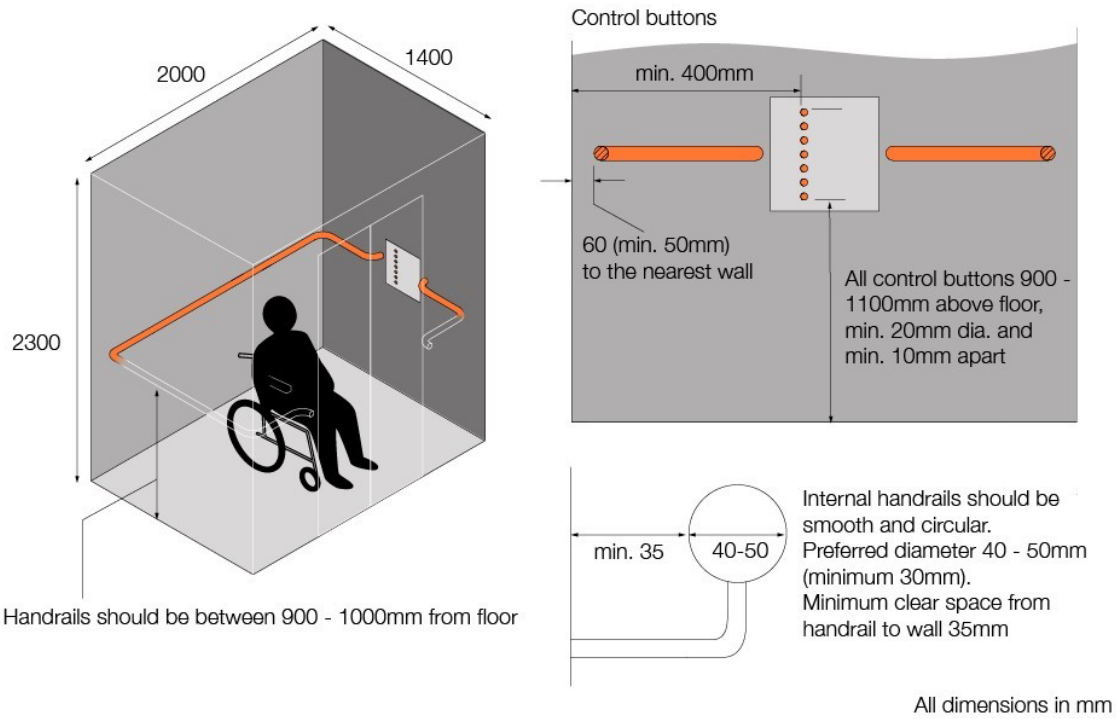
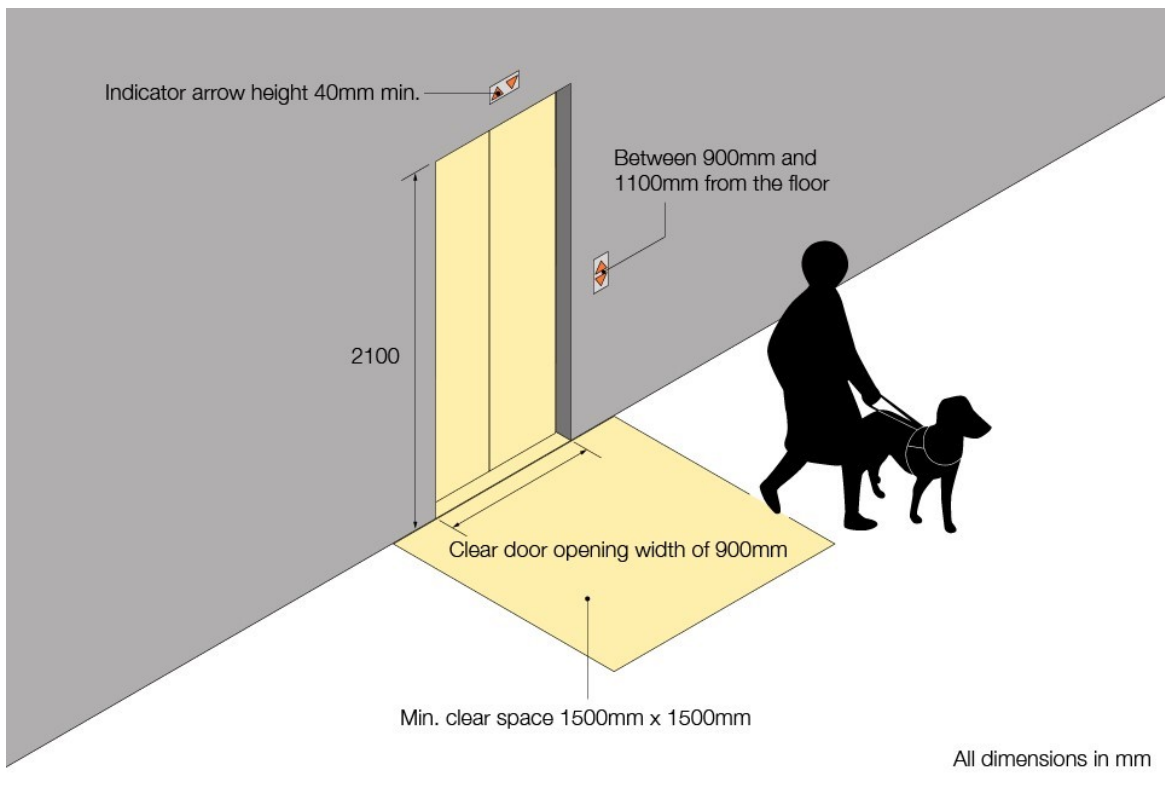

Figure 7: Lift exterior



Handrails should be available on the inside walls of a lift, at a height of between **900** and **1000mm**, and should also tonally and colour contrast with the interior. The dimensions of the handrails should conform with those specified in Section 5.3, where possible, but a lack of space may dictate a compromise. However, any handrail inside the lift should have a minimum diameter of **30mm** with at least **35mm** clear space between the handrail and the lift wall. There should be a clear space preferably of **60mm** (minimum **50mm**) between the handrail and any adjacent wall. The handrail should not continue across the control panel, as this might obstruct its use, and the ends of the rail should be closed and turned in, to minimise the risk of injury.

All control buttons should be positioned between **900** and **1100mm** above floor level and be at least **400mm** from an internal corner and any other obstruction. Control buttons on the inside and the outside of the lift should have symbols in relief for the purpose of providing tactile information. They should, of course, be tonally and colour contrasted with their background, or be easily visible due to having internal illumination. The buttons should be **20mm** in diameter (or 20mm x 20mm if square), be at least **10mm** apart and protrude from the outside wall or inside wall of the lift cabin. Control panels should include instructions in Braille and in relief, with the latter using characters that are at least **15mm** in size and raised **1mm** from the surface. The force needed to press the buttons should be between **2.5** and **5N**.

For a lift with dual, centre opening doors, the control panel should be located on users' right-hand side as they enter the lift. With side opening doors, it should be on the closing side. Control panels should always be on the flank wall of the lift, not on the wall in front of, or behind, a wheelchair user.

Visual information displays inside the lift should be positioned just above head height, at **1800** to **1900mm** above the lift floor, to ensure a clear sight line when the lift is full. Display panels should have minimum dimensions of **60mm x 50mm**. For electronic displays of information, ideally lettering should be yellow or light green with a black background.

An emergency call system inside the lift is essential and, should it be used, there must be a swift response. There should also be an external communication system on all lift landings to enable communication with a central controller, should a lift not be in service. Emergency buttons inside the lift should have an embossed tactile legend and be positioned at the bottom of the control panel no less than **890** to **900mm** above the floor. There should

also be a two-way voice communication device in the lift, installed at a height of **1200** to **1220mm**. If communication is provided via a handset, it should have a minimum cord length of **735mm**. However, a 'push and talk' facility is preferable. To ensure that the communication system is accessible for people with a hearing impairment, an acoustic coupler and volume control should be provided. A yellow illuminated pictogram should indicate that the alarm has been activated and a green illuminated pictogram should indicate that the emergency call/alarm has been registered. The audible signal for voice communication should have a sound level that is adjustable between **30** and **55dBA**. As well as the control panel being at least **400mm** away from the corner of the lift cabin, there should be no fittings or objects between the panel and the floor extending more than **100mm** from the lift wall. Simple written and pictorial information explaining emergency procedures should be provided.

The stopping accuracy of a lift is important from the point of view of whether lift occupants need to negotiate a change in level when exiting. Such a step might be more than some wheelchair users can cope with and present a trip hazard for others, so the maximum step created when the lift stops should not exceed **10mm**. Any horizontal gap should not exceed **20mm**.

There should be a clear and obvious way of showing an intending user if a lift is not working. This might include warnings of the lift not working, placed on routes leading to the lift, with advice on alternative accessible routes.

Passenger lifts that are intended to evacuate disabled people in an emergency must have an independent power supply and meet the relevant recommendations of BS 9999:2017. Safety rules for the construction and safety of lifts can be found in BS EN 81-20:2020.

5.7 Footbridges, tunnels and underpasses

While it is preferable to have at grade crossings, there are places where a bridge or underpass has to be provided. The design of road- and rail-related footbridges, tunnels and underpasses is largely governed by the good practice standards on stairs, ramps, lifts and handrails given earlier in this section. It is worth remembering that the headroom to be accommodated on an underpass is usually less than that required for a footbridge, so the length of ramp and stairway will also be less.

The approach to an underpass should be as wide as possible, to provide an open aspect and give users a sense of security. CCTV cameras, which should provide full coverage within the underpass, will further enhance security levels and deter vandalism, and give the feeling of a safer environment. It is recommended that the underpass itself should have a width of at least **4800mm** and a clear height of at least **3000mm**. Within the underpass, handrails set at **1000mm** above the walking surface should be provided on both sides. There should be a clear view from one end to the other and a level of lighting of at least **50 lux**.

5.8 Platforms: rail services

Passenger platforms should be built on a straight section of track so that the gap between the platform and the rail carriage is minimised. However, there is sometimes a trade-off to be made between locating a station on a straight section of track and locating it where it is most easily accessible, and economic and engineering factors also have to be taken into consideration. If a platform has to be installed on a curved section of track, it is recommended that the radius of curvature should not exceed **600 metres**; if possible, at least part of the platform should be on a straight section of track. Where a curve causes a gap between the rail carriage and the platform edge, an announcement should be made to alert passengers to the potential hazard.

The required width of a platform is influenced by the (maximum) number of passengers using it and is also defined according to the width of the “danger area”, which is the area, commencing from the rail-side edge of the platform, in which passengers are not allowed to stand when trains are passing or arriving. Guidance on how the width of the danger area influences platform width requirements, and information on how the danger area shall be

indicated using visual and tactile markings, is contained in the Department for Transport's National Technical Specification Notice Persons with Reduced Mobility (PRM NTSN). However, a minimum clear space of **2000mm** should be maintained. There should also be a white line, **100mm** wide, at the platform edge and the appropriate tactile paving surface should be installed to warn that the platform edge is near. Details of the use of tactile paving surfaces on platforms can be found in the Department for Transport's publication *Guidance on the Use of Tactile Paving Surfaces*.

The surface of platforms should comply with all aspects of good practice associated with flooring, being even, slip-resistant and non-reflective. For all types of platform, any crossfalls needed for drainage should slope down from the front edge to the rear edge of the platform and have a gradient not exceeding **1 in 40**. Drainage gullies should, if possible, be avoided on platforms, as they can cause problems for wheelchair users. Where they are necessary, they should be covered.

Equipment such as vending machines should be placed clear of the unobstructed space along the platform and should be tonally and colour contrasted with their surroundings. Parallel posts supporting information signs should have a tapping rail between them with a depth of at least **150mm** and a lower edge that is no more than **200mm** from the ground. This is to prevent vision impaired people from inadvertently walking between the posts and colliding with the sign. Columns and other projections into the passenger circulation area should be avoided, if possible; if present, they should be highlighted using tonal and colour contrast.

At least one Help Point (for information and use in an emergency) should be provided on each platform, with controls (raised push buttons) and a communication link at a height of about **1200mm** from the platform's surface. Wherever possible, the Help Point should provide both visual and audible means of communication. Similarly, any audible announcements giving information on delays or changes of platforms etc. should be provided visually as well, as should any emergency announcements.

The height of rail station platforms is normally 915mm, which does not enable level boarding onto trains. However, the kinematic envelope required by a moving train (particularly freight trains) means that any increase in platform height would have to be offset by an increase in the horizontal distance between the train and the platform edge. This means that access to trains in

heavy rail systems for wheelchair users entails the use of a mobile ramp or an on-train lift. Modern light rail systems, however, are normally built with platforms that provide level boarding; if there is a gap, a ramp has to be carried on the vehicle.

Additional guidance on the accessible design of rail platforms can be found in BS EN 16584:2017 Railway Applications. Design for PRM Use. General Requirements, including Part 1 (Contrast), Part 2 (Information) and Part 3 (Optical and Friction Characteristics). Further advice is available in Network Rail’s Inclusive Design document, which provides guidance on the design and implementation of inclusive and accessible railway stations and other occupied buildings throughout the rail network.

Figure 8: Rail platform

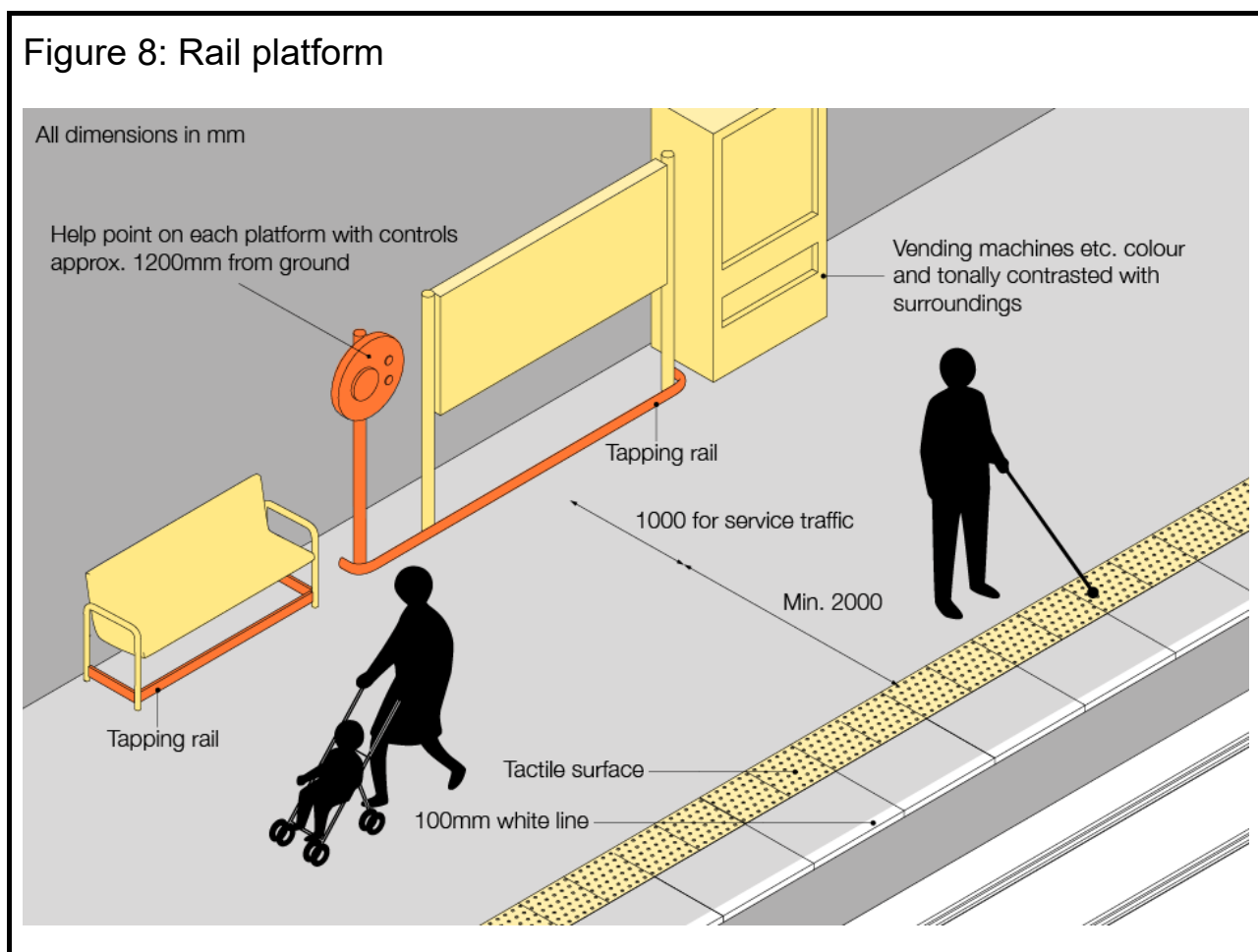

5.9 Platforms: rail services off-street

Where the rear of the rail platform is open, there must be a raised kerb or 'kicking board', which may be used as a tapping rail by long cane users, in addition to rails or fencing. The bottom edge of such a board should be no more than **200mm** above ground level and it should have a depth of **150mm**. Again, details of the use of tactile paving surfaces on this type of platform can be found in the Department for Transport's publication *Guidance on the Use of Tactile Paving Surfaces*.

5.10 Platforms: rail services on-street

The height of on-street light rail train (LRT) platforms is dictated by the floor height of the rolling stock used. Low-floor LRT designs tend to be such that the platforms need be no more than 350mm high in order to enable level access to the train. Although the height of the platform is relatively low, it should still be marked with the appropriate tactile warning surface (see *Guidance on the Use of Tactile Paving Surfaces*) and should also have a white strip along the edge of the platform. Access from the pavement to the platform should be by means of a shallow ramp, and protection must be provided if the rear of the platform is open.

It should be noted that stairs, ramps and lifts may form part of an escape route in the event of an emergency. Specific requirements for fire precautions in relation to rail infrastructure are contained in BS 9992:2020.

6. Tactile paving surfaces

Tactile paving surfaces play an important role, conveying information that vision impaired people can detect with their feet or with a cane. Six different surfaces are designated for use, each having a different texture to convey various messages. Five of the surfaces are used on the public highway, with the sixth being used only on railway and underground station platforms.

While only a small proportion of vision impaired people have no sight at all, many have sufficient residual vision to detect contrasts in tone and colour. Contrasts in colour and tone should be used to accentuate the presence of certain key features, including the presence of tactile paving.

The six designated surfaces are illustrated in Figure 9. Full details of their dimensions and application can be found in *Guidance on the Use of Tactile Paving Surfaces*.

Figure 9: Six tactile paving surfaces

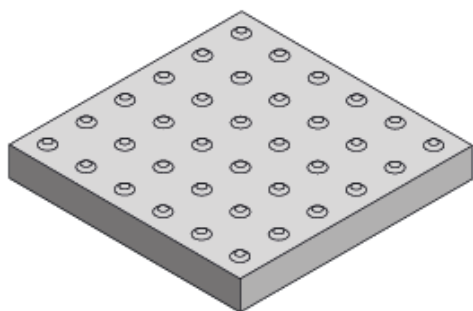

Blister surface for pedestrian crossing points

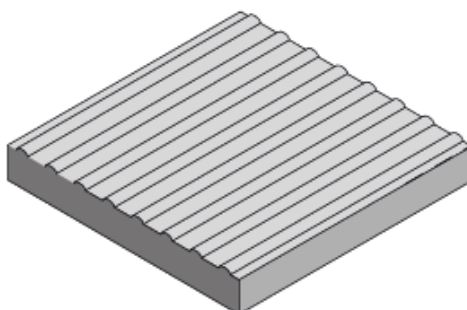

Corduroy hazard warning surface

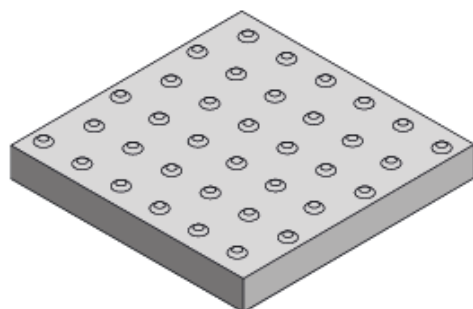

Platform edge (off-street) warning surface

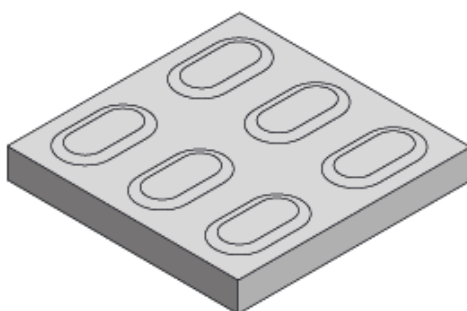

Platform edge (on-street) warning surface

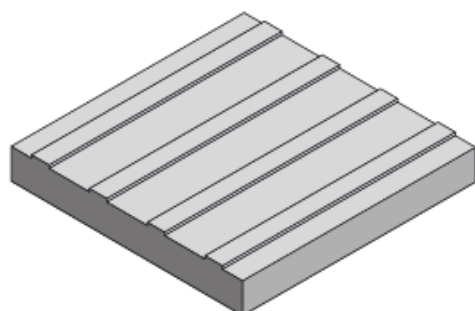

Segregated shared cycle-track/footway surface

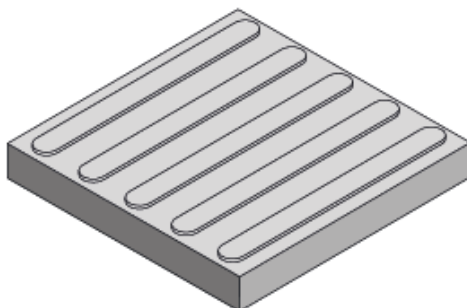

Guidance path surface

6.1 Blister paving surface for use at pedestrian crossing points

Purpose

The blister surface is for use only at designated pedestrian crossing points, and its purpose is two-fold. Its general purpose is to provide a warning to vision impaired people who, in the absence of a kerb upstand greater than 25mm high, may otherwise find it difficult to differentiate between where the footway ends and the carriageway begins. At controlled crossing points only, the blister surface is also used to act as a guide (usually referred to as a stem) that leads vision impaired people to the crossing point itself.

Definition

The profile of the blister surface comprises rows of flat-topped 'blisters', **5mm ($\pm 0.5\text{mm}$)** high, arranged in straight lines in a rectilinear pattern. In each row there are six blisters per row and six rows on a 400mm x 400mm paving module, making **36** blisters per module. Paving modules are available in different sizes, albeit with the same blister heights and spacings.

The blister surface should be red at controlled crossings. The colour red should not be used for any other tactile paving surface, nor for the blister surface at uncontrolled crossings. The blister surface at uncontrolled crossings is usually buff but may be any colour (other than red) that provides a contrast with the surrounding surface.

6.2 Corduroy hazard warning surface

Purpose

The purpose of the corduroy surface is to warn vision impaired people and other people of the presence of specific hazards, including steps, railway level crossings, the approaches to on-street tram and other Light Rapid Transit platforms, locations where people could inadvertently walk directly onto a railway station platform and the transition from **footways** to areas shared with other users (e.g. cyclists).

Definition

The profile of the corduroy surface comprises rounded bars **6mm ($\pm 0.5\text{mm}$)** high, 20mm wide and spaced 50mm from the centre of one bar to the centre of the next running transversely across the direction in which people will be walking. There are **eight** bars on 400mm x 400mm modules.

6.3 Platform edge (on-street) warning surface

Purpose

The purpose of the platform edge (on-street) warning surface is to warn vision impaired people that they are approaching the edge of an on-street tram or Light Rapid Transit (LRT) platform.

Definition

The profile of the platform edge (on-street) warning surface comprises rows of 'lozenge' shapes. The lozenge shapes are 6mm (± 0.5 mm) high and have rounded edges in order not to be a trip hazard. There are **six** lozenges on a 400mm x 400mm module.

6.4 Segregated shared cycle track/footway surface (Ladder and Tramline) and central delineator strip

Purpose

Local Transport Note 1/20 (Cycle Infrastructure Design) is clear that shared use routes in streets with high pedestrian or cyclist flows should not be used. Where it cannot be avoided, shared use may be appropriate if well-designed and implemented and where pedestrian numbers are very low. Cycle tracks and footways should be designed to be perceived as wholly separate facilities. Where it is not possible to achieve this level of separation, and the footway and cycle track are immediately adjacent and parallel to one another, the guidance in this section should be followed. This will assist vision impaired people and will also be helpful to all other users.

The purpose of the central delineator strip is to help vision impaired people, other users, and cyclists keep to the correct side. However, as noted in LTN 1/20, it is difficult to maintain and may be disregarded by pedestrians. A kerb at least 50mm high or a strip of light-coloured material that can be detected with a cane is likely to be more effective at helping visually impaired people to detect and negotiate the track. This could be achieved by using an alternative raised strip which is trapezoidal in cross section, or some other textured material.

Local Transport Note 1/20 Cycle Infrastructure Design provides further information and guidance.

Definition

The profile of the segregated shared cycle track/footway tactile paving surface comprises a series of raised, flat-topped bars, each 5mm (± 0.5 mm) high, 30mm wide and spaced 70mm apart. There are **four** bars on a 400mm x 400mm module.

On the footway side, the surface should be laid so that the bars are transversely across the main direction of travel for people walking (it is called the 'ladder' surface in this orientation). On the cycle track side, the surface should be laid so that the bars are in line with the main direction of travel for people cycling (it is called the 'tramline' surface in this orientation).

The (trapezoidal) central delineator strip is **12-20mm** high (preferably **20mm**), **150mm** wide with sloping sides and a flat top of **50mm**. It is the only tactile paving surface element that is prescribed within Traffic Signs Regulations and General Directions 2016, Diagram 1049.1).

6.5 Guidance path surface

Purpose

The purpose of the guidance path surface is to guide vision impaired people along a route when the traditional cues, such as a property line or kerb edge, are not available. It can also be used to steer people around obstacles, for example street furniture, in a pedestrianised area. Unlike the other tactile paving surfaces described here, the guidance path surface is for amenity, rather than to serve as a warning of the approach to a hazard. The surface was designed so that people can be guided along the route, either by walking on the tactile surface, or by maintaining contact with a long cane.

Definition

The profile of the guidance path surface comprises a series of raised, flat-topped bars running in the direction of pedestrian travel. The bars are 5.5mm (± 0.5 mm) high, 35mm wide and are spaced 45mm apart. There are **five** bars on a 400mm x 400mm module.

6.6 Platform edge (off-street) warning surface

Purpose

The purpose of this surface is to warn vision impaired people of the proximity of the edge of all off-street rail platforms, including heavy rail platforms, underground platforms and off-street tram or other LRT platforms, and is not for use on the public highway.

Definition

The profile of the platform edge (off-street) warning surface consists of offset rows of flat-topped domes 5mm (± 0.5 mm) high, spaced 66.5mm apart from the centre of one dome to the centre of the next. The offset alignment of the blisters distinguishes this surface from the surface used to warn of the absence of a kerb upstand at pedestrian crossing points.

7. Making cycling facilities accessible to all

7.1 The importance of making cycling infrastructure accessible

This document is concerned with the provision of accessible infrastructure and services for all transport users, including cyclists. This section provides guidance on both the use of cycles by disabled people, often as a mobility aid, and the need to ensure that cycling infrastructure is safe and accessible to other users.

This section will frequently make reference to recommendations and guidance contained in Local Transport Note 1/20 Cycle Infrastructure Design (LTN 1/20) on the accessibility of cycling infrastructure.

7.2 Cycles as a mobility aid

Some people use a cycle as a mobility aid which helps them to get around or to carry items or passengers. Their cycle might not be a specially adapted version – it may simply be a conventional model that enables them to travel when they cannot walk very far, or drive. Some people may use an adapted cycle, a handcycle or a tricycle as a mobility aid, and a vision impaired person might also cycle using a tandem. While disabled people may use a cycle in this way, legally it is considered to be a cycle and therefore cannot be used in areas where cycling is not permitted, unlike an invalid carriage, which is defined in the Chronically Sick and Disabled Persons Act 1970 as “a vehicle, whether mechanically propelled or not, constructed or adapted for the carriage of one person, being a person suffering from some physical defect or disability”, and which is permitted for use on the footway under certain conditions. It is permissible to ride an e-cycle on cycle lanes and tracks, because they are treated as pedal cycles for design purposes.

The use of a cycle as a mobility aid is growing and research by Transport for London (which was quoted by the charity Wheels for Wellbeing in its publication ‘A Guide to Inclusive Cycling’) found that 12% of disabled people cycle “regularly” or “occasionally”, compared with the equivalent figure of 17%

for non-disabled people. According to a Wheels for Wellbeing survey carried out in 2019-20, which involved a sample of 213 disabled cyclists, 65% cycled at least once a week, most owned a two-wheeled cycle and approximately 65% used their cycle as a mobility aid.

7.3 General design principles for cycling infrastructure

All cycling infrastructure should be coherent, direct, safe and comfortable, as well as accessible for all those who wish to use it. Neither its design nor positioning should create hazards for vulnerable pedestrians.

To maximise the inclusiveness of cycling facilities, the minimisation of effort should be a key design consideration. This might include, for example, avoiding gradients wherever possible (with the directness of a route considered with this in mind). Local Transport Note (LTN) 1/20 (Table 5-8) makes specific recommendations about the maximum length for given gradients, and these include the following:

Gradient	Maximum length
1:50	150 metres
1:25	50 metres
1:20	30 metres

LTN 1/20 provides general advice on width requirements that are based on the concept of the 'cycle design vehicle', which is up to 2800mm long and up to 1200mm wide, with the outer radius of the minimum turning circle of this hypothetical vehicle being up to 3400mm. LTN 1/20 advises that, for design purposes, it should be assumed that two cyclists travelling side by side on a level surface require a minimum space of **1000mm** each, with an additional separation space of **500mm** between them. As a design principle, however, the minimum recommended width should only be provided in locations where there is a physical constraint that makes it impossible or infeasible for more space to be allowed.

LTN 1/20 also provides guidance on the accessible design of cycle lanes. It states that cycle lanes less than 1500mm wide should not be used, on the grounds that they will exclude the use of the facility by larger cycles and might also encourage 'close-passing' of cyclists by the drivers of motor vehicles. LTN 1/20 instead recommends that cycle lanes should be at least **2000mm** wide, as this will also allow one cyclist to overtake another.

It is important that cycle routes be designed to cater for significant numbers of cyclists and be suitable for 'non-standard' cycles, such as recumbent cycles, tricycles, handcycles and any other cycle that might be specially adapted for a disabled user. LTN 1/20 states that tricycles, quadricycles and cycle trailers typically have an axle width of 800mm, cycle trailers are usually about 800mm wide and adapted cycles can have a width of up to 1,200mm. Pointing out that additional width will be required where cyclists need to negotiate uneven surfaces or drainage gullies, LTN 1/20 emphasises that such obstacles might cause particular problems for users of tricycles and quadricycles, which can become unstable if a wheel drops into a gully or a pothole; because of this, sufficient space should be provided to enable them to take evasive action. Three- and four-wheeled cycles can also be affected by excessive camber, making them hard to steer. Therefore, any crossfall or camber on a cycle route should be adequate for drainage but not excessive, and it should fall to the inside of a bend. LTN 1/20 advises that the crossfall or camber of a cycle route should have a gradient of no more than **1:40 (2.5%)**.

An important consideration when designing an accessible cycling network is that a disabled cyclist might be unable to dismount from their cycle.

7.4 Cycle parking

Detailed recommendations on the design and provision of cycle parking facilities are provided in Local Transport Note 1/20, and these provide the basis for the guidance presented in this sub-section.

The availability of accessible, convenient and secure cycle parking facilities can play an important part in enabling a disabled person to make a journey by cycle. For this reason, provisions for parking facilities must be included in any proposed substantial schemes, and the needs of all potential users, and the full range of cycles that might be used, should be considered. It is also important for details of cycle parking to be advertised. Cycle parking, and routes to and from it, should be clearly marked, well maintained, overlooked by neighbouring buildings and properly lit. All elements of cycle parking facilities should conform to accessible design principles related to street furniture (Section 4.7).

Conversely, security will tend to be the primary consideration for longer stay parking, with features such as CCTV monitoring, shelter from the weather and being separate from the main flow of pedestrians being valued more highly than convenient access. Note, the principle of siting the facility in order to avoid excessive walking distances for disabled cyclists still applies. The pedestrian route to and from cycle parking facilities, intended for the use of disabled cyclists, should, of course, be accessible.

Personal security within cycle parking areas may also be a concern if the parking is remote and not overlooked by adjacent buildings. Cycle parking, and routes to and from it, should be clearly marked, overlooked, well-maintained, well-lit and integrated into the built environment. Specific areas should be set aside for three-wheeled cycles, which are problematic to secure to traditional upright hoops, in the most accessible parts of a large cycle park so that they can also be used by disabled people with adapted cycles. Accessible cycle parking should normally also be placed close to accessible car parking spaces.

Isolated cycle stands for short-term parking should be configured to bear in mind the length of cargo bikes and tandems, and the width of tricycles and side-by-side cycles. Bays intended to accommodate tandems, cycles with trailers and other larger cycles designed specifically for use by disabled people, should have a length of **3000mm (2500mm minimum)**. For a row of

spaces where it is the end one designed for use by people with larger cycles, the access aisle should have a minimum width of **3000mm (1800mm minimum)**; if it is intended that users of larger cycles should use internal bays, then the access aisle should have a minimum width of **4000mm (3000mm minimum)**. Bays intended for three-wheeled cycles should have at least **2000mm** between stands.

LTN 1/20 recommends that a proportion of the cycle parking (typically 5%) should be provided for non-standard cycles to accommodate disabled people. LTN 1/20 suggests minimum cycle parking capacity for different types of land use; for a major public transport interchange, the suggestion is capacity for **one per 200 daily users** and, for a “standard stop”, facilities should be provided “upon own merit”. Spare capacity should always be provided to cater for growth and turnover. The effect of new infrastructure should also be factored into any decisions about planned reserve capacity of cycle parking facilities.

7.5 Signing

Signing for cycle facilities is prescribed in TSRGD (2016). Design guidance is provided by the Traffic Signs Manual. A key recommendation is that signs should be positioned so they are visible for all cyclists, including recumbent cyclists, whose eye level will be lower.

In particular, there should be complete clarity as to where a cycle route runs. The important principle is that cyclists should not need to stop on the route in order to consult a map or their phone. Where signs are erected above footways and cycle tracks, adequate clearance is required for pedestrians and cyclists. A minimum height of **2300mm** for pedestrians and **2400mm** for cyclists is recommended – see Chapter 1 of the Traffic Signs Manual. Signs on bollards are typically mounted at least 0.8m high to ensure they can be easily seen, and signs on walls placed at a height of 1.5m.

The design of road markings is covered in Chapter 5 of the Traffic Signs Manual. All markings should be clear and regularly maintained to ensure they remain legible.

7.6 Traffic calming, speed reduction and access control measures

As a principle, access control measures, such as staggered barriers that require cyclists to dismount, should not be used. This is because they both reduce the usability of a route for everyone and may exclude users of 'nonstandard' cycles. Physical interventions should not be used to, for example, reduce the speed of cyclists approaching a junction; instead, cyclists should be provided with good sightlines and road markings to alert them to the need to take care and give way to pedestrians or other traffic.

7.7 Surface materials and maintenance

It is particularly important for disabled cyclists to be able to use routes that are surfaced with a smooth material that is resistant to water damage. Surface treatments using block paving and other materials in order to make a visual and audible statement that a section of cycle route is a low-speed environment should not be used. This is because such interventions can cause discomfort for disabled cyclists.

Surfaces should also be regularly maintained to prevent the development of potholes, or the accumulation of mud, fallen leaves, snow or ice, all of which may be hazardous for cyclists. Detailed guidance on surfacing and maintenance of cycle routes is given in LTN 1/20.

7.8 Making cycling infrastructure safe for disabled pedestrians

The risks that cycling infrastructure can present to disabled pedestrians fall into two broad categories: hazards and barriers presented by the physical infrastructure itself; and the risks of conflict where they have to share the same space with cyclists. LTN 1/20 provides detailed guidance on designing cycle infrastructure with vulnerable pedestrians in mind. There is some potential for conflict between pedestrians and cyclists where a cycle route passes a bus or tram stop. In such circumstances, a 'bus stop bypass', sometimes referred to as 'floating bus stop', may be installed. The purpose of a bus stop bypass is to prevent cyclists from having to manoeuvre around a bus when it stops, potentially coming into conflict with fast-moving motor vehicles. Cyclists are routed behind the bus stop instead, in order to balance the risk for different types of user. An alternative arrangement is a 'bus

boarder', where the cycle route continues on a course between the kerb where the bus stops and the area where people wait for the bus.

An issue that arises with each of these configurations is that, while the objective of separating cyclists and motorised vehicles is achieved, it creates potential conflict between cyclists and pedestrians. This can be of particular concern for more vulnerable pedestrians and bus users, including people who are vision impaired, those who are deaf or who have a hearing impairment, older people, people with a learning impairment and people who are neurodiverse, who might fail to perceive danger in the same way as others.

Because of the potential for conflict between cyclists and bus users, a bus boarder should only be considered at bus stops that have less frequent services and where passenger / pedestrian volumes are low. However, various measures for making bus bypasses accessible are recommended in LTN 1/20 Cycle Infrastructure Design. The first recommendation is that engagement should take place with relevant groups of people from an early stage of the planning and design process. This should include organisations representing older and disabled people, as well as older and disabled individuals themselves. This will provide a forum to hear and address any safety concerns that they may have.

It is very important that bus bypasses and boarders are designed so that they are accessible and safe for both cyclists and pedestrians. Various measures for making bus bypasses accessible are recommended in LTN 1/20 and these are described in Section 9.7.

8. Car parking

8.1 General Provision

Car parking should be accessible and easy to use, with designated accessible spaces as close as possible to the main entrance to the facilities served by the car park (for off-street parking) or to shops and services (for on-street parking).

Provision should be made for designated accessible car parking spaces for disabled motorists and passengers (Blue Badge holders) wherever parking is provided.

On-street parking relates to parking on the carriageway: the Blue Badge Scheme is designed to enable disabled people to park, on-street, closer to their destination.

Off-street parking such as car parks provided by or for local authorities, private companies, and transport providers, should include designated accessible spaces to facilitate access for Blue Badge holders and other disabled drivers and passengers. These should be clearly marked as being reserved for Blue Badge holders using both road markings and vertical signs.

To assist wheelchair users and those with mobility and other impairments, reserved spaces should be larger than regular parking spaces to provide extra room for getting in and out of a vehicle. Detailed guidance on the design of accessible car parking is provided in sections 8.3 and 8.4, in British Standard BS 8300, in guidance for the Building Regulations and the Scottish Building Standards, and guidance developed jointly by the Department for Transport and Transport Scotland.

Ideally, designated accessible spaces should be located adjacent, or as close as possible, to the entrance to the facility they serve, and no more than **50 metres** away. The route between parking place and venue should be well maintained with no obstructions to access. Pedestrians should not be expected to cross a road when travelling to or from the car park, but, where this is unavoidable, dropped kerbs should be provided to ensure level access

(Section 4.11), along with any other measures necessary to ensure pedestrian safety. Where a dropped kerb is installed and pedestrians are expected to cross a road, an appropriate tactile paving surface should be used (Section 6.1).

In locations where it is not possible to have accessible car parking close to a facility, reasonable provision should be made so that all people who need to travel to a facility by car can reach the principal entrance, or an alternative accessible entrance, of the building. Disabled people who arrive as passengers should be able to alight from a vehicle using a setting down point which is as close as practicable to this entrance. The purpose of this is to provide a safe area, out of the main flow of traffic, where disabled people may be dropped off or picked up by a car driver, at or very close to the venue. This area should be on firm and level ground, and the pavement or [footpath](#) at the setting down point should be level with the road.

Consideration should be given to providing a weather shelter over designated accessible spaces. There should also be a clear and unbroken chain of signage to direct disabled motorists or drivers with disabled passengers to designated spaces. It is important, too, that car park operators monitor these spaces and take appropriate action to prevent misuse.

Where multi-storey car parking is provided, spaces reserved for disabled people should be on the same level, or levels, as the main public pedestrian access to the facility. Where this is not possible, these spaces should be located as near as possible to an accessible lift (Section 5.6 for recommendations relating to lifts).

8.2 The recommended number of designated accessible spaces in different contexts

The recommended proportion of designated accessible parking spaces for Blue Badge holders is as follows:

(i) for car parks associated with existing employment premises: **2%** of the total car park capacity, with a minimum of **one space**.

Spaces for disabled employees must be additional to those recommended above; reservations could be ensured, for example, by marking a space with a registration number.

(ii) For car parks associated with newly built employment premises: **5%** of the total parking capacity should be designated (to include both employees and visitors).

(iii) For car parks associated with shopping areas, leisure or recreational facilities, and places open to the general public: a minimum of **one space** for each employee who is a disabled motorist, plus **6%** of the total capacity for visiting disabled motorists.

The numbers of designated accessible spaces may need to be greater at hotels and sports stadia that specialise in accommodating groups of disabled people.

The Design Standards for Accessible Railway Stations Joint Code of Practice published by the Department for Transport and Transport for Scotland sets out the National standards on the numbers of designated and accessible parking spaces for staff and visitors at railway station and advises that, if all designated spaces are occupied for more than 10% of the car park's operating hours, the operator should consider increasing their number.

8.3 The design of accessible parking spaces: off-street

Designated accessible parking spaces should be located on firm and level ground. The surface of such spaces should be even and stable, with any variation of surface profile not exceeding **± 5mm** (e.g. between paving, surface features or different surfaces). A designated accessible space should be a minimum of **4800mm** long and **2400mm** wide. Where the spaces are perpendicular to the access aisle, an additional width of **1200mm** should be provided on each side. This extra width may be shared with adjacent spaces. An additional zone of **1200mm** should be provided, at the vehicle access end of the space to enable rear access. This will enable a rear hoist to be deployed.

Where an off-street designated accessible space is parallel to the access aisle, an additional zone of at least **1800mm** should be created to enable access from the side.

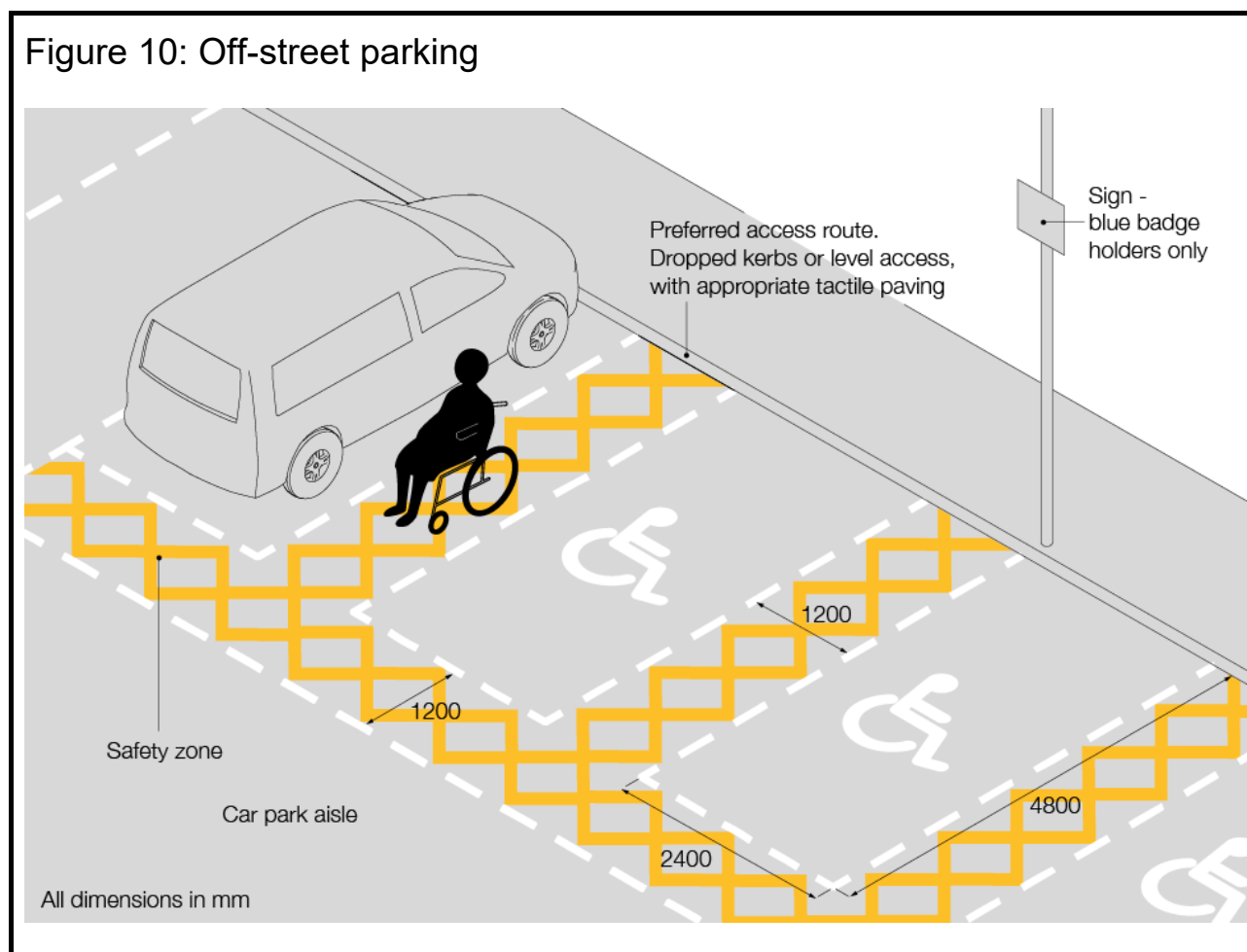

Designated accessible parking spaces provided in off-street locations should be designed as per Figure 10. There should be a raised sign at the head of the designated bays, to ensure that the purpose of the bay is apparent should road markings become faded or obscured. For reasons of best practice and consistency in operation for users, it is recommended that off-street car parks should follow TSRGD (2016), which does not specify the yellow lines in this diagram, even though these do not apply off-street.

Wherever designated accessible spaces are at a different level from the adjacent pavement, a dropped kerb should be provided for wheelchair users, with an appropriate tactile paving surface.

Direction signs should be provided for guidance to the location of the designated spaces in the car park. Signs should also be provided to indicate an accessible pedestrian route from those spaces to the venue that the car park serves.

8.4 The design of accessible parking spaces: on-street

Signs and markings used to indicate on-street parking spaces reserved for Blue Badge holders must comply with the requirements of TSRGD (2016). Advice on design is given in Chapter 3 of the Traffic Signs Manual. In order to be enforceable, a Traffic Regulation Order must be made by the traffic authority setting out the restrictions on use of the bay by other users, and time limits, where appropriate. Advisory bays are not permitted under TSRGD (2016). For on-street parking parallel to a kerb, the recommended size of each space reserved for Blue Badge holders must be at least **6600mm** long and **2700mm** wide (or **3000mm** wide when in the middle of the road). For on-street spaces reserved for Blue Badge holders set at an angle to the kerb, the length of the largest rectangle that can be accommodated within a row of angled spaces must be at least **4200mm** and the width of each space must be at least **3600mm**.

Wherever reserved on-street parking is provided for Blue Badge holders, the gradient or camber of the road should not exceed **1 in 50**; a road with a steep camber causes difficulties for wheelchair users who have a side lift in their vehicle.

Figure 11: On-street parking at an angle to a kerb

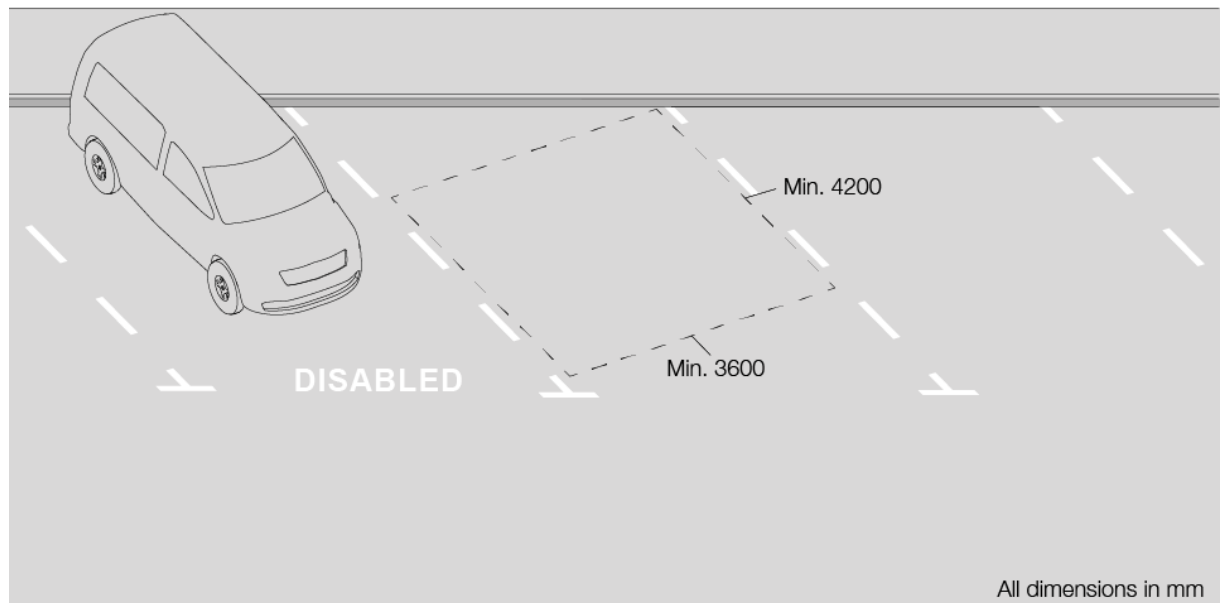
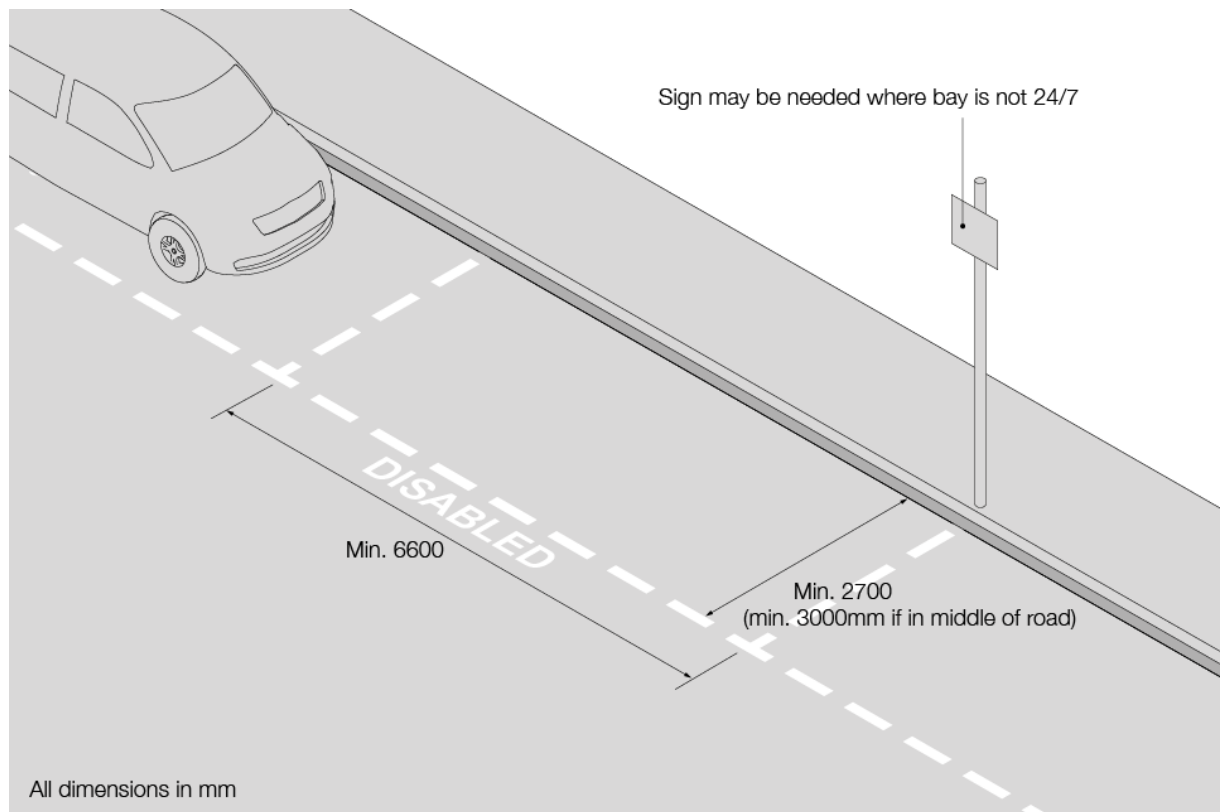

Figure 12: On-street parking parallel to a kerb



8.5 Control systems associated with designated accessible spaces

Information about any control systems used should be freely available (online or by other means), so that disabled motorists may research what to expect before they travel. This could include information on the charging regime (if there is one) for Blue Badge holders and details of any ticket machines or barriers that disabled motorists might have to use. If Blue Badge holders are required to pay to park, there should be signs that clearly state this. Preferably, there should be a variety of payment options available (such as contactless or pre-payment). However, if there is no alternative, then at least one 'pay & display' machine should be located near to the designated accessible spaces and be clearly visible from them.

The design of pay and display machines, parking meters etc. should conform to the standards given in Section 11.4. Ticket dispensers and slots for coins or cards that need to be operated from a wheelchair should not be less than **750mm** and not more than **1200mm** high. Any information displays or control instructions should be centred **1500mm** above ground level. Keypads on those parking machines that require registration numbers to be typed in should be no more than **1200mm** high.

Access to the ticket machine should take account of the space at foot level needed by a wheelchair user and machines should not be placed on a plinth. If a plinth is necessary, it should not extend beyond the face of the equipment. To allow wheelchair users to manoeuvre in front of the machine, there should be a clear space of **1850mm x 2100mm**.

Barrier control units (for coin or card entry and ticket issue) should be between **1000mm** and **1300mm** above the ground, with instruction plates placed at the lower end of the range.

It is also essential that the maximum acceptable height of vehicle is shown on the approach to the car park. Some disabled motorists use a van or a high-topped car; others use a car with their wheelchair stowed on top of the vehicle, so height can be critical. It is recommended that the minimum vertical clearance from carriageway to designated accessible spaces should be **2600mm**. This height is sufficient for a car carrying a wheelchair on its roof and for the wheelchair to be positioned vertically during the hoisting process.

If it is not possible to maintain this height along the route to the designated spaces, information to that effect, specifying the minimum clearance, must be displayed prominently so that the driver of a higher vehicle has time to avoid entering the car park. At the same point, directions to a suitable alternative parking area must be displayed.

It is also important for car park users to have a means of communicating with parking control staff in case of having difficulties with using the equipment.

9. Bus, Light Rapid Transit (LRT) and tram stops

The use of low-floor buses has improved the accessibility of public transport. This section provides guidance on accessibility at boarding places for buses, trams, LRT, and similar transport systems, important parts of the public transport network.

9.1 The siting of bus stops

In residential areas, bus stops should ideally be located so that nobody in the neighbourhood is required to walk more than **400 metres** from their home. The spacing of bus stops should also take account of the gradients in the terrain within the vicinity of stops. A suggested standard is to reduce the maximum distance by **10 metres** for every **1 metre** of rise or fall. Such ease of access will help to remove barriers to the use of bus services.

In addition, bus stops should be sited as close as is feasible to popular facilities including retail and employment centres, schools, recreation facilities, residential care homes, day centres, and other transport services. There should also be a pedestrian crossing (and a dropped kerb with an appropriate tactile paving surface) in reasonable proximity. Any pedestrian crossing or dropped kerb should conform to the accessibility standards that are described in Sections 4.10 and 4.11, respectively.

On single-carriageway roads it is normal practice to stagger bus stops in opposing directions so that buses stop 'tail-to-tail' and move away from each other. The stagger should be a minimum of **40 metres** and may have a pedestrian crossing between the stops. As a matter of general policy, highway authorities should ensure that dropped kerbs or other approaches are provided wherever there is a need to do so so that wheelchair users can get to stops.

The benefits of low floor buses are negated if they cannot draw up close to the kerb at bus stops. Bus stop clearway signs and markings that prohibit parking at bus stops must conform to TSRGD (2016). Advice is also provided in Chapter 3 of the Traffic Signs Manual.

9.2 Raised bus boarding areas

A raised bus boarding area assists passengers getting on and leaving the vehicle and may enable some wheelchair users to board directly without using a ramp. There are two types of bus boarder: full width and half width. A full width boarder juts out into the carriageway approximately **1800mm** - far enough for the bus to avoid parked vehicles. The length of the boarder will depend on the type of bus using the stop and whether or not a shelter is provided. For a conventional single entry / exit bus, where there is no shelter, a raised area of **3000mm** in length is recommended. Where buses with two doors are used, it is recommended that the raised boarding area should be at least **9000mm** long. A half width raised bus boarding area, which protrudes by between **500** and **1500mm**, is a compromise design that can be used where a full width version would unduly delay other traffic, or position buses too close to the on-coming stream of traffic.

The standard kerb height for raised bus boarding areas ranges from **125** to **140mm**; above this height, it is recommended that specialised bus stop kerbs be used, which can provide a height up to 220mm. A higher kerb may be appropriate where there is a segregated bus system or where the vehicle is guided into the stop. A decision as to the optimum height of the kerb is often a compromise between providing easy access for passengers and the potential for damage to buses.

Where a raised bus boarding area is provided, care should be taken to keep the transition gradient to an acceptable level, preferably no steeper than **1 in 20** (**1 in 12** maximum). (Section 4.3 for recommendations relating to gradients and crossfalls). Raised bus boarding areas should be carefully designed in relation to drainage.

A tactile warning surface is not recommended for use on raised bus boarding areas.

9.3 Shelters

Shelters should be provided where there is space to do so. From the point of view of disabled passengers, particularly wheelchair users, the best location for a shelter is opposite the boarding point. Because of space constraints this may not be possible; an alternative is to place the shelter downstream,

leaving **2000mm** length of clear boarding / alighting area. In locations not exposed to severe weather, a cantilever bus shelter with one end panel offers good accessibility and some weather protection. Where the end panel is used for advertising, it should be at the downstream end of the shelter so that people can see the bus or tram approaching. In more exposed locations enclosed shelters should be provided, if there is space to do so.

For reasons of personal security, the shelter should be made mainly of transparent material and be well lit at night, although the use of other materials may be more appropriate in rural areas. Where glass or transparent walls are used they should have permanent markings to make the glazing apparent. These should be continuous or broken bands, which might incorporate logos, with a depth of approximately 150mm, of a tone and colour selected to contrast visually with the background seen through the wall, and positioned between 1400mm and 1600mm from the ground. A second, lower band may be put between 850mm to 1000mm from the ground.”

There should be sufficient space either to the rear of the shelter, or in front of it if the shelter has to be placed at the back of the pavement, to allow easy pedestrian movement. Where shelters are provided in newly built areas there should be a clear obstacle-free footway width of at least **2000mm**, preferably **3000mm**. These dimensions should also be used where practical, when improvement work on highways is being carried out.

However, it is recognised that at many existing stops it is not possible to achieve these standards. Where there are physical constraints, a clear footway width of **1500mm** is acceptable, with an absolute minimum of **1000mm** over a limited distance (for example, that occupied by the shelter, provided that it is not more than **6 metres** long).

The Public Service Vehicles Accessibility Regulations 2000 state that the maximum acceptable angle of a boarding ramp shall be **1 in 8** from a vehicle step height of 250mm down to a reference kerb height of 125mm. This means a minimum ramp length of **1000mm**. To allow adequate manoeuvring space for a wheelchair user, the unobstructed boarding area at the stop should be **2000mm x 2000mm**. Where an open-fronted passenger shelter is used, part of this boarding area may extend into the sheltered area. This layout, with the canopy of the shelter 1400mm in depth, requires a total **footway** width of ideally **4700mm** (absolute minimum **3700mm**).

If the shelter is placed downstream of the boarding area, with its closed side to the carriageway, the total footway width required can be reduced to **4000mm** (absolute minimum **3000mm**).

It is also suggested that a **100mm** yellow line be provided on the **footway**, offset **450mm** from the kerb (to the outer edge of the line) at stops, replicating that used on railway platforms. At bus stops this will provide guidance to bus drivers and indicate to passengers that they should keep away from the kerb-edge.

Where a fully enclosed shelter is used allowance must be made for manoeuvring space for wheelchair users both into and within the shelter. It is recommended that shelters of this type should be **2000mm** in depth and with a minimum of **1500mm** clear footway space between the rear of the shelter and the inner edge (or heel) of the footway to allow the wheelchair user space to turn into the shelter entrance. However, as with the other types of shelter, the clear footway to the rear should be **2000mm** if possible, giving a total footway width of **4600mm**. If the enclosed shelter is placed at, rather than downstream of, the bus boarding area the exit from the shelter onto the bus boarding area should be **2000mm** wide, with the shelter itself set back from the kerb edge by a minimum of **1000mm**.

9.4 Seating at stops

Seating should be provided where possible – and recommendations for accessible seating can be found in Section 11.5. Shelters should incorporate a bench, a platform or horizontal rails that passengers can rest against, at a height of about **580mm**. Any seating should be tonally and colour contrasted with its surroundings and, if not under cover, be designed so rainwater does not collect on it. The seating should also leave sufficient clear space to enable a wheelchair user to manoeuvre within the shelter.

9.5 Stop flags

The design principle for positioning a stop flag is that it should be fixed as low as possible, while remaining visible above road traffic, pedestrians and any other nearby obstacle. However, the bottom of the flag should be at least **2500mm** from the ground. Ideally, the flag should be positioned so as to be visible to passengers from inside the bus or tram, so that they know where

they are. Having a raised, capital letter “B”, about **20mm** in height, positioned on the post at the stop at **1000mm** from the ground will help vision impaired people. There should be a clearance of **600mm (500mm minimum)** between the stop post and the kerb edge. The visibility of the post should be enhanced by the application of tonally and colour contrasting banding, at least **150mm** deep and positioned at a height of approximately **1500mm** from the ground (ideally between **1400** and **1600mm**).

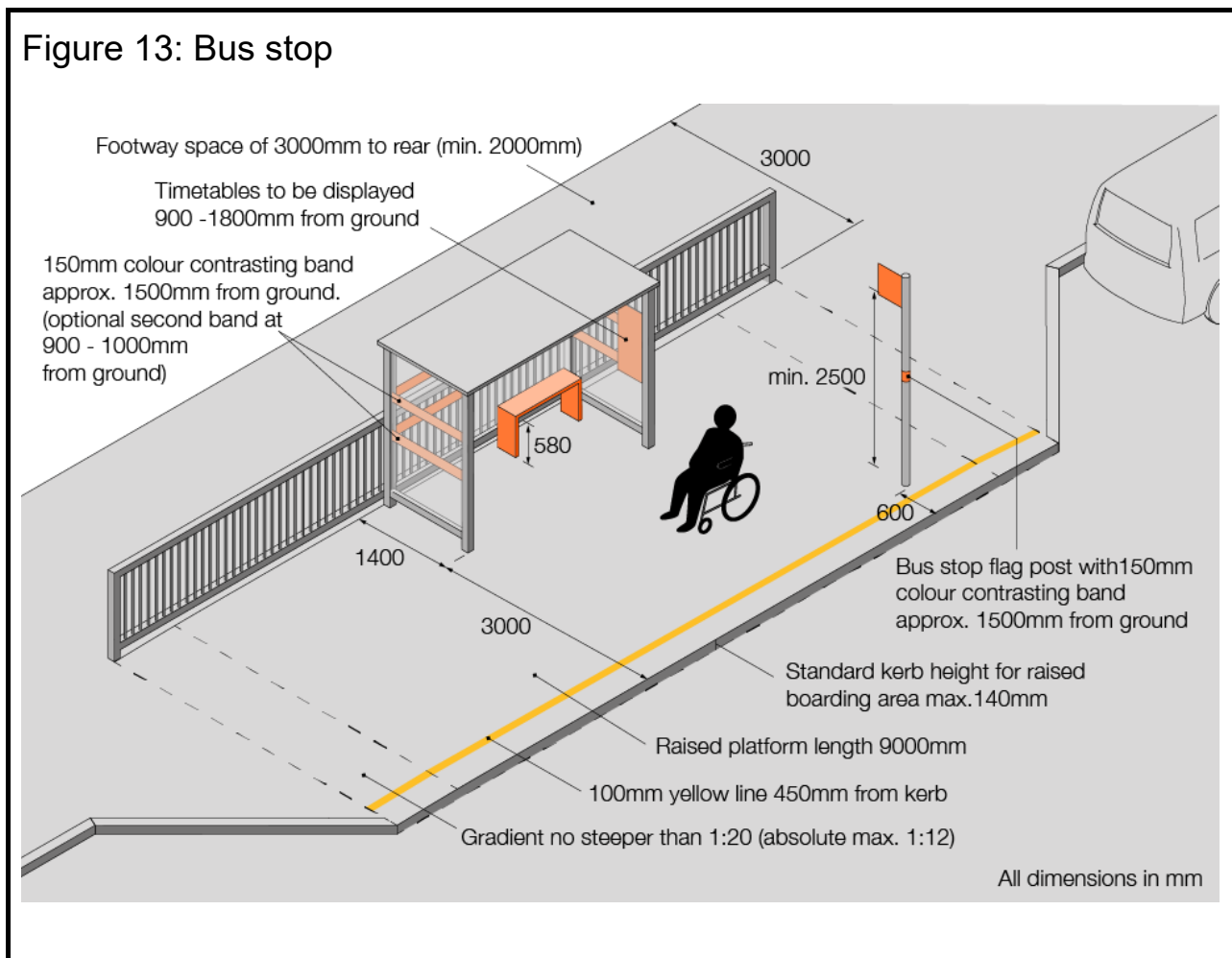

Stop flag signs are prescribed in diagrams 970, 973.2 and 973.3 of TSRGD (2016).

To avoid confusion, the flag should contain only a pictogram of a bus, which is a prescribed element, and the name (or number) of the stop, route

numbers, the direction of travel (i.e. the name of the next town or principal destination), the logo or identity of the operator or transport authority as appropriate, a telephone number for information and any specific messages for users.

Identifying the name of the stop enables automatic on-bus announcements. For stops used by a substantial number of services, it is better to provide this information on a timetable display, rather than overcrowd the flag with route numbers, reducing its legibility.

Stops should be well lit, so information may be seen and for users' personal security; in low light conditions it may be necessary to illuminate the bus stop flag itself.

9.6 Timetable information

Service timetable information should be provided at as many stops as feasible. Timetable and information displays should be located between **900** and **1800mm** in height. Information of particular relevance to wheelchair users should be positioned towards the bottom of the display and any important information should appear at a height of no more than **1700mm**. If surrounding street lighting is inadequate, then additional lighting should be provided at the stop itself.

Information provided should include, as a minimum, details of routes and destinations served, and departure times. Full timetables and route diagrams are helpful to public transport users unfamiliar with services. This is essential, too, for longer routes and less regular services. Details of other stopping places in the vicinity, and routes servicing them, can minimise confusion where routes cross or where there is more than one stopping place. Other helpful information which might be provided includes website addresses of the bus operator, and devices such as QR codes, from which passengers might obtain further service information.

Identifying the name of a stop enables consistency with automatic on-bus announcements. Labelling stops with letters or numbers can also be helpful where many routes use the same stop and at complex junctions or picking-up points. Where this system is used, each stop's identifying letter or number should be clearly displayed on the flag. A map of the location of stops at

major interchanges is also helpful. In addition, operating companies' contact details including telephone and textphone numbers should be clearly displayed.

Both audio and visual information should be provided wherever possible. Visual displays showing the expected arrival times of buses or trams at stops, destinations served and any delays are helpful for all passengers, but particularly so for people who are deaf or who have a hearing impairment. Where real-time information such as this is provided as described in section 12.3, and with the screen displaying it shielded from direct sunlight.

Voice activated information systems and information systems triggered by fobs or mobile phones will assist people who are vision impaired.

9.7 Bus stop bypasses

Local Transport Note 1/20 provides guidance on these and that it is essential that the needs of pedestrians are taken into account, particularly disabled people.

It sets out that pedestrian crossing points at these should be controlled if cycle traffic speed and flow are high. Where a bus/tram stop bypass is being considered, early engagement with relevant interested parties should be undertaken, particularly those representing disabled people, and pedestrians and cyclists generally.

It would be helpful if announcements on board buses included information on the of bus bypass or bus boarder stops.

10. Taxi ranks

Wherever feasible to do so, taxi ranks should be provided adjacent to railway, bus and coach stations, and all major trip attractors such as retail areas. If possible, ranks should be located close to the facility being served, with clear signing within the facility showing where they are. Taxi ranks should be sited so that passengers board or alight onto the footway from the near-side of the vehicle.

The width of unobstructed footway should be sufficient to allow the deployment of wheelchair ramps (up to **1620mm**) and adequate manoeuvring space for the wheelchair user. The suggested total width is **4040mm**.

A dropped kerb or raised road crossing should be provided close to the rank if passengers need to cross a street to get to or from the taxis, together with the appropriate tactile paving surface.

Ranks should be clearly signed and have seating close by. Additionally, consideration should be given to lighting and might also be given to facilities such as shelters.

Information might be provided at the rank on services available and calling a taxi. If the rank does not have taxis regularly standing at certain times, the information might explain these times. It can be helpful including for blind or partially sighted people to provide embossed information, QR codes, or a button that can be pressed for audible information.

11. Transport buildings: access and facilities

This section focuses on recommendations for ensuring ease of access to public transport buildings for all users, and free movement within them. It covers the main principles for the accessible location of stations, terminals and interchanges, the internal accessibility of these buildings and the accessibility of important facilities and services necessary during the course of a journey by public transport.

11.1 The location of stations, terminals and interchanges

An accessible public transport network will need accessible stations, terminals and interchanges. Although this guide is primarily concerned with the design of specific features in the built environment, it is worthwhile mentioning the wider principles that should determine the location and general layout of such facilities.

Public transport can seldom provide door-to-door services, so journeys will involve passengers transferring from one mode to another or, at the very least having to walk from a station or terminal to their final destination. Ideally, interchanges and bus/coach stations should be located at, or immediately adjacent to, other transport services and local shops and passenger destinations.

Routes leading to a station entrance from connecting services, car parks and drop-off points should be accessible (Section 4). The guidance path tactile paving might be appropriate to improve accessibility. It is hard to improve access to stations once they are operational, so it is essential that, from the start, there is accessible provision for walking and cycling, and for interchange from road-based transport, i.e. private cars, buses and taxis. It is also important that all passengers are able to find the entrance to a facility easily, so there should be clear and accessible signing (Section 13). This should preferably be the main public entrance.

The size and layout of stations and interchanges will be dictated by the frequency and pattern of services, but it is important to use as compact a layout as possible, to minimise walking distances. For this reason, a two-level station, provided there is good access between the levels, may be better than a more extensive single-level site. A compact layout with passenger facilities concentrated in one area will also be easier to supervise and may present passengers with a less stressful, more secure environment than one with more isolated spaces.

In facilities where passengers are transferring from one means of transport to another, or between services, the potential for conflicts between pedestrians and moving (road) vehicles should be minimised.

The layout of a bus station will depend, among other things, on the dimensions of the site and the number of buses using it. There are a number of basic station layouts that might be adopted, including oblique-angled bays, saw-tooth bays, 'L', 'U' or horseshoe layouts, and islands. Island stations, however, are not recommended, since the requirement for buses stopping around a central island site will entail passengers having to cross their path, or negotiate a change of level. Obliquely angled bus bays require buses to reverse out of stands, which can be a hazard, although physically separating pedestrians from the reversing area will minimise danger.

Wherever passengers must cross the path of buses, very clearly marked fixed crossing points, with level access and priority for pedestrians, are essential. Such crossing points should be fitted with appropriate tactile paving surfaces to indicate the presence of the crossing (Section 6.1). Details of their dimensions and application can be found in *Guidance on the Use of Tactile Paving Surfaces*.

11.2 Entrances and doors

Accessibility can be compromised if the entrance to a building has even a single step, or a kerb without a ramp in the road outside. If possible, entrances to stations should not have doors, though this is not always feasible, for reasons of security or climate control. Where there are doors, they should preferably be automatic, linked either to a weight sensor or to sensors mounted above the door. Such sensors need to be carefully set so that the doors they control offer protection for passengers from the weather.

The sensitivity of sensors is an important consideration for passengers who are particularly vulnerable and who might, for example, have to wait inside a station for a taxi. Manual doors are difficult for many people to manage, particularly wheelchair users. Revolving doors are not well suited to many people, including disabled people, but if they are installed, an alternative hinged or sliding door must be provided in close proximity.

Doorways, once open, should preferably have a clear width of **1200mm** (**900mm** is the minimum acceptable). Where double leaf doors are installed, each leaf should be **900mm** wide (**800mm** minimum). Space immediately before and after a door is also important, to allow people to stand clear if the door opens towards them, and to give wheelchair users space in which to manoeuvre. There should be a clear, level area of **1500mm** on each side of the doorway, at the very least, but preferably more than this. Where there are two doors in series, there should be a minimum space between them of **1340mm**, plus the width of any door opening into this space. If an area of **2000mm** can be achieved, then this will make manoeuvring in a wheelchair much easier.

Automatic sliding doors (Figure 15) are recommended in preference to manually operated doors (Figure 14) and should remain open for a minimum of **6 seconds**, but preferably **9 seconds**, and should not open faster than **3 seconds** to back check. Many automatic doors incorporate a time delay device whereby the doors close automatically after a prescribed time lapse. Such doors can be hazardous to wheelchair users and some people with a mobility impairment. Automatic sliding doors are also preferred to automatic hinged doors that open towards an approaching pedestrian.

The operation of automatic doors can be triggered by a sensing device, or by foot or hand pressure on a pendant switch or push button. The most suitable means of operation is through contact with a pressure mat, where doors are held open for as long as the area on either side is occupied. With this mode of operation, mats must be sensitive to pressure exerted unevenly (for example, by crutch users) and to light pressure (for example, pressure exerted by an assistance dog). If the doors are controlled by a push button, it is recommended that the button be located **800mm** from floor level and a similar distance from the side of the door. This button should be illuminated and tonally and colour contrasted with its surroundings. Where doors are operated by photoelectric cells, a 'Z' pattern of light beams will ensure that doors remain open if people are moving slowly. The pressure required to stop

doors closing should not be more than **66.6N (15lbf)**. In the event of a power failure, it must be possible to move the door freely by hand.

If manual doors are used, handles should be of the lever type and it must be possible to open the door with minimal effort: some people are unable to exert a force greater than 13.3N (3lbf). It is recommended that any manual door should be operable using the palm of the hand and exerting a force of no more than **15N**. If the handle is horizontal, it should be at a height of **900mm** and it should have a minimum length of **120mm**. If the door is opened with a vertical bar, then this should stretch from **700 to 1400mm** above floor level. A door handle or bar is recommended to be **30 to 35mm** in diameter and, as with any handle or rail, there should be a gap of at least **45mm** between it and the surface of the door to prevent people from catching their knuckles on the door frame. Doors should also be fitted with a 'kick plate' of **400mm** in depth at the bottom of the door.

Where glass is used in a door, it must be safety glass. However, clear glass doors can be a hazard for vision impaired people, so use of this material should be avoided, if possible, except to provide a viewing panel, which should extend from adult eye level down to **500mm** from the floor. Where doors made of glass or another translucent material are installed, they should have permanent markings to make the glazing and its edges apparent. These should be continuous or broken bands, which might incorporate logos, with a depth of approximately 150mm, of a tone and colour selected to contrast visually with the background seen through the door, and positioned between 1400mm and 1600mm from the ground. A second, lower band may be put between 850mm to 1000mm from the ground.

Thresholds should be level, but if this is not possible the maximum acceptable threshold rise is **10mm**; any greater than 5mm should have a bevelled edge. Doormats should be flush with the floor finish. Rubber-backed mats placed on top of the existing floor finish can ruck and present a trip hazard and should not be used. Coir dirt mats and mats with a directional weave are also not recommended, on the grounds that they can impede access for people who have a mobility impairment, as well as wheelchair users.

Doors should be tonally and colour contrasted with the wall near them with handles similarly contrasted with the doors. There should also be a lighting

transition zone immediately inside the entrance to enable adjustment from the brightness outdoors to a more dimly lit interior or vice versa.

If there is a canopy over an entrance, care should be taken to ensure that the supporting structure is either incorporated into the building fabric, positioned on a verge or clearly marked with tonally and colour contrasting banding approximately **150mm** in depth and with a lower edge approximately **1500mm** from the ground.

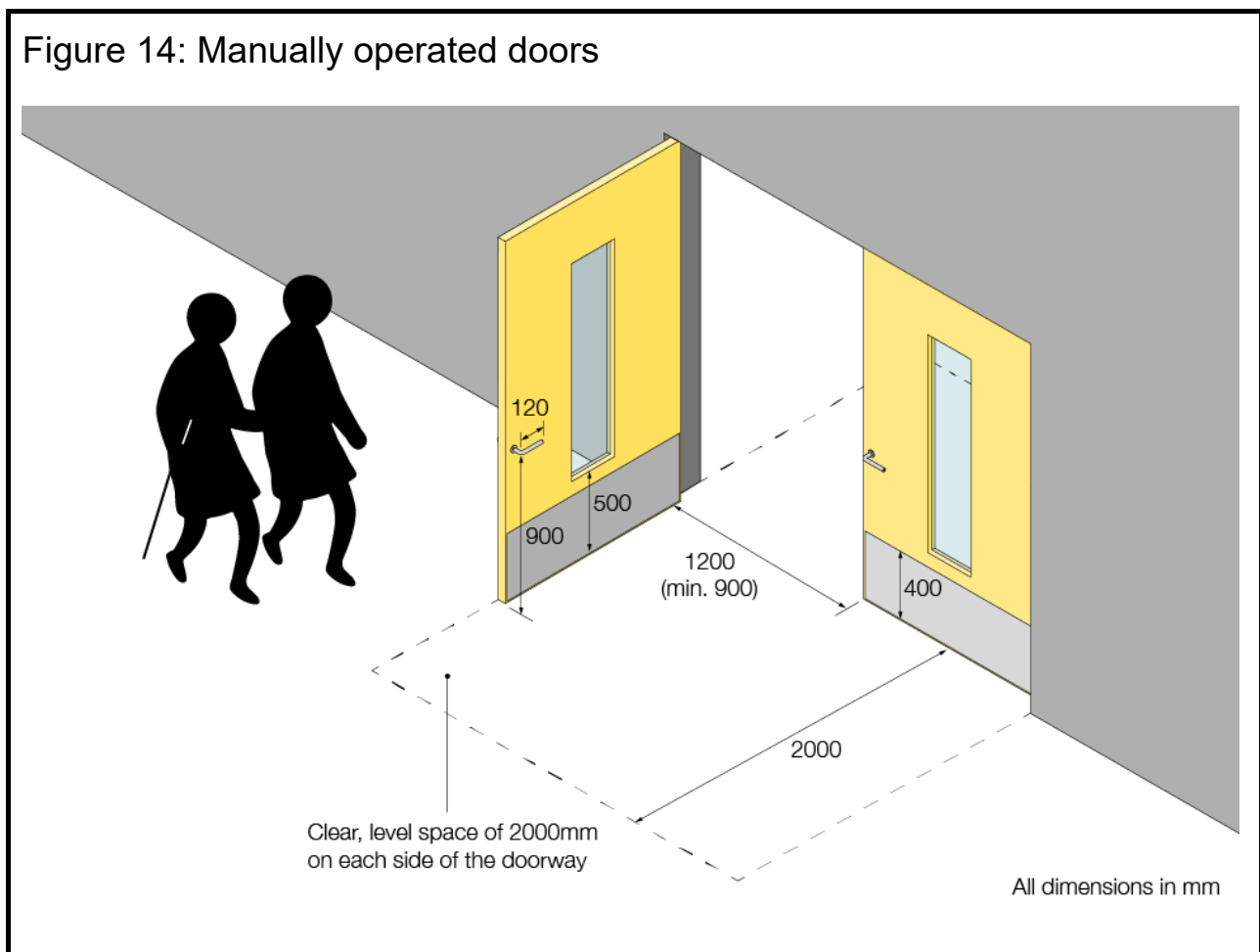
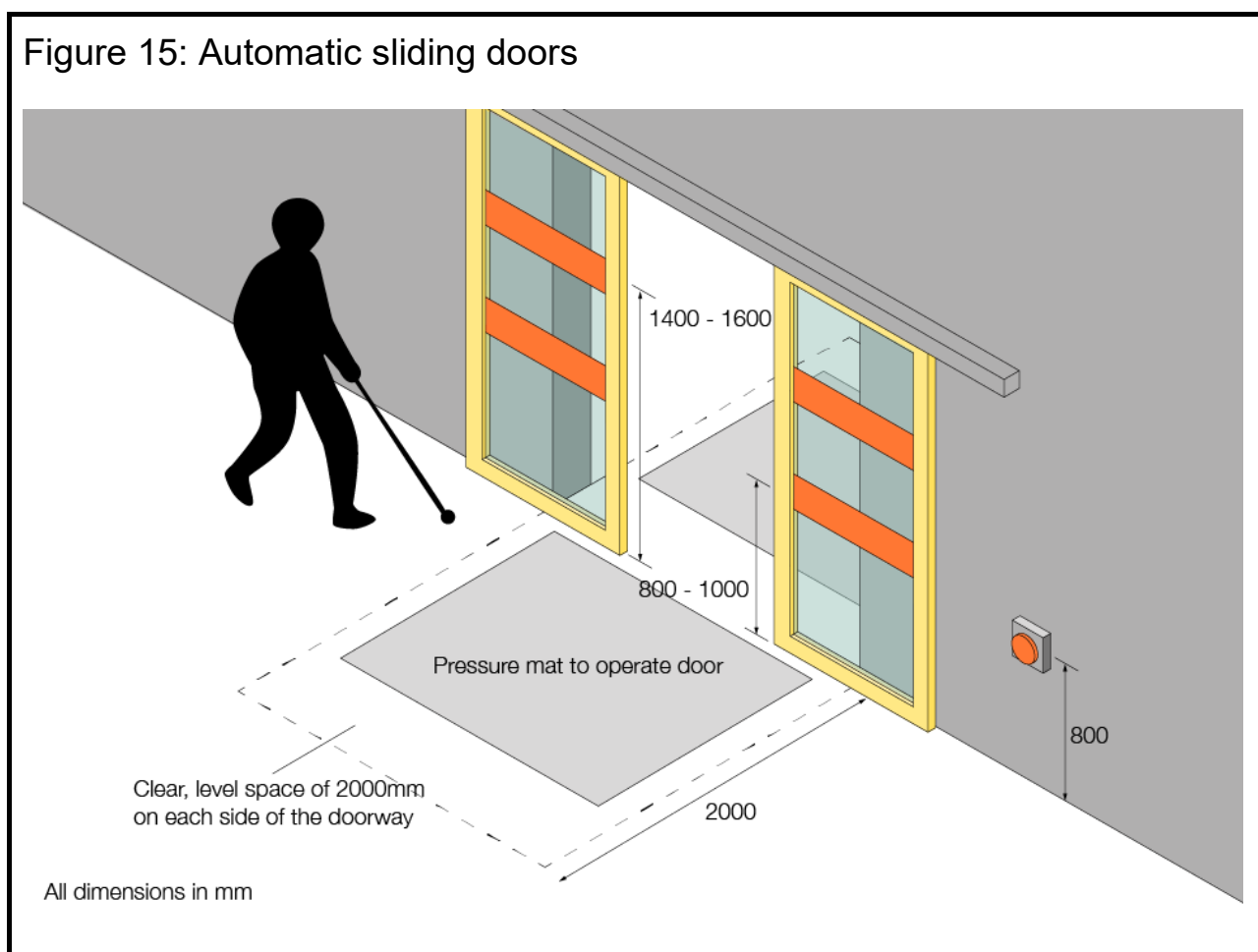

Figure 15: Automatic sliding doors



11.3 Passageways and general access within buildings

A two-way corridor should have a minimum width of **2000mm**, as this enables two wheelchair users to pass each other, as already recommended in Section 4.2. However, where an access route is predominantly less than 1800mm wide, passing places should be provided to allow two wheelchair users to pass. Such passing places should be a minimum of **2000mm** long and a minimum of **1800mm** wide, with each one located within direct sight of the next, or at a maximum distance of **50 metres** from another, whichever is the closer. Where it is necessary to introduce occasional narrowing of the access route, the restricted width should not be less than **1000mm** and should extend for no more than **6000mm**.

Well-designed corridors help every user to find their way through a building. Vision impaired people generally navigate by focusing mainly on the part of

the floor up to 1500mm in front of them. Floor finishes are therefore instrumental in helping them to find their way. They should incorporate landmarks that might include one or a combination of features, such as visible cues, tactile indicators, sounds etc. For example, the corduroy hazard warning surface (Section 6.2) should be used to indicate that stairs are being approached. Other cues might include the use of particular flooring materials in certain areas of the building, or the use of particular sounds. Such cues and symbols should be consistent throughout a building.

The end wall of a corridor should be highlighted by, for example, being tonally and colour contrasted with the rest of the corridor, and/or with a change in lighting. Glare caused by windows positioned at the end of corridors or passageways can be reduced by using tinted glass or with anti-glare treatment or blinds. Walls should have light coloured, non-reflective surfaces and should tonally and colour contrast with the floor so that the boundary with the floor is clearly visible.

A corridor should have sufficient space to enable a wheelchair user to make a right-angle turn within an area of **1200mm x 1200mm** and a 180° turn within an area of **1600mm (width) x 2000mm (length)**.

The Department for Transport's National Technical Specification Notice Persons with Reduced Mobility (PRM NTSN) provides additional information on how vision impaired people can be assisted with identification of an obstacle-free route through a railway station using visual and tactile cues.

11.4 Ticketing and information

Service counters for ticket sales and information offices should have a height of **760mm** so they are accessible for wheelchair users and others who require a lower counter (Figure 16). There should also be clear knee space, of **750mm** high, **500mm** deep and at least **900mm** wide, below the counter to enable a wheelchair user to get close to it. There should also be a clear space at least **1200mm** wide in front of the counter in which a wheelchair user can manoeuvre. A support handrail, the top of which should be at a height of between **900mm** and **1000mm** from the floor, should be provided at the side of each ticket office window. Because some people find standing, even for a few minutes, difficult and painful, handrails should be provided in queueing areas so that people waiting can use them for support.

The design of the counter top is also important. Some counters have a large-radius curve on the top leading edge and this can make it difficult for some people to pick up their ticket(s) and other items from the counter. A slight upstand at the front edge of the counter can facilitate this. The counter top should also be designed so that glare and reflection from both natural and artificial lighting are minimised.

Every service counter should have a hearing loop for people who use a hearing aid and a sign should be displayed to advertise the availability of this facility. An intercom unit should be mounted at a height of **1100mm** from the floor; this ensures that there will be no visual barrier between the employee in the ticket office and the passenger. Where there is a glass screen partition, consideration should be given to installing a voice transfer system. This can potentially benefit both hearing aid users (including those whose device has a 'T'-switch), and people with a hearing impairment who do not normally rely on a hearing aid for communication. Glass screens should also be non-reflective so that a person who relies on lip-reading or facial gestures can see the staff member's face.

Where information centres have textphones, these should be well located and readily accessed by information centre staff. Cash tills should display amounts due for payment for tickets so that they can be easily seen by the ticket purchaser. Wherever possible, ticket and information offices should be located in a quiet area, well away from the noise of the concourse.

Many rail systems have ticket barriers at both entry and exit points. Standard designs of barriers are not accessible to wheelchair users and are difficult for other disabled people. For this reason, the availability of assistance for passengers who need it should be clearly signed at each ticket barrier, as should an alternative, accessible route through the ticket checking and collection area. The Department for Transport / Transport Scotland Design Standards for Accessible Railway Stations states that disabled passenger should be offered parallel access through such control points, which may be controlled by staff or be automatic.

Similarly, automatic ticket vending machines have become an increasingly common feature of transport systems, so it is important that they too are designed to be accessible. The two most important aspects are that they have a simple operation, and that all interactive parts of the machine are within reach of wheelchair users. In addition, a ticket machine will be

accessible to vision impaired users if it has a function for communicating with the user by audio means.

The operational features of ticket vending machines should consist of a straightforward three or four-step procedure. For example: 1. Select destination zone; 2. Select ticket type; 3. Pay fare; 4. Collect ticket.

To ensure that ticket machines are physically accessible, any interactive element of such a machine should be between **750mm and 1200mm** from the ground (Figure 16). Placing controls or other features towards the extremes of this range should be avoided, if at all possible. There should be a clear space of **1850mm x 2100mm** in front of the machine, in which wheelchair users can manoeuvre. Push buttons should be **20mm** in diameter, protrude slightly and tonally and colour contrast with their surrounds, and machines should not be placed on a plinth that extends beyond the face of the machine. Ticket and change dispensing points should be large enough for people with limited manual dexterity to be able to use them without difficulty.

Figure 16: Ticketing / information counter

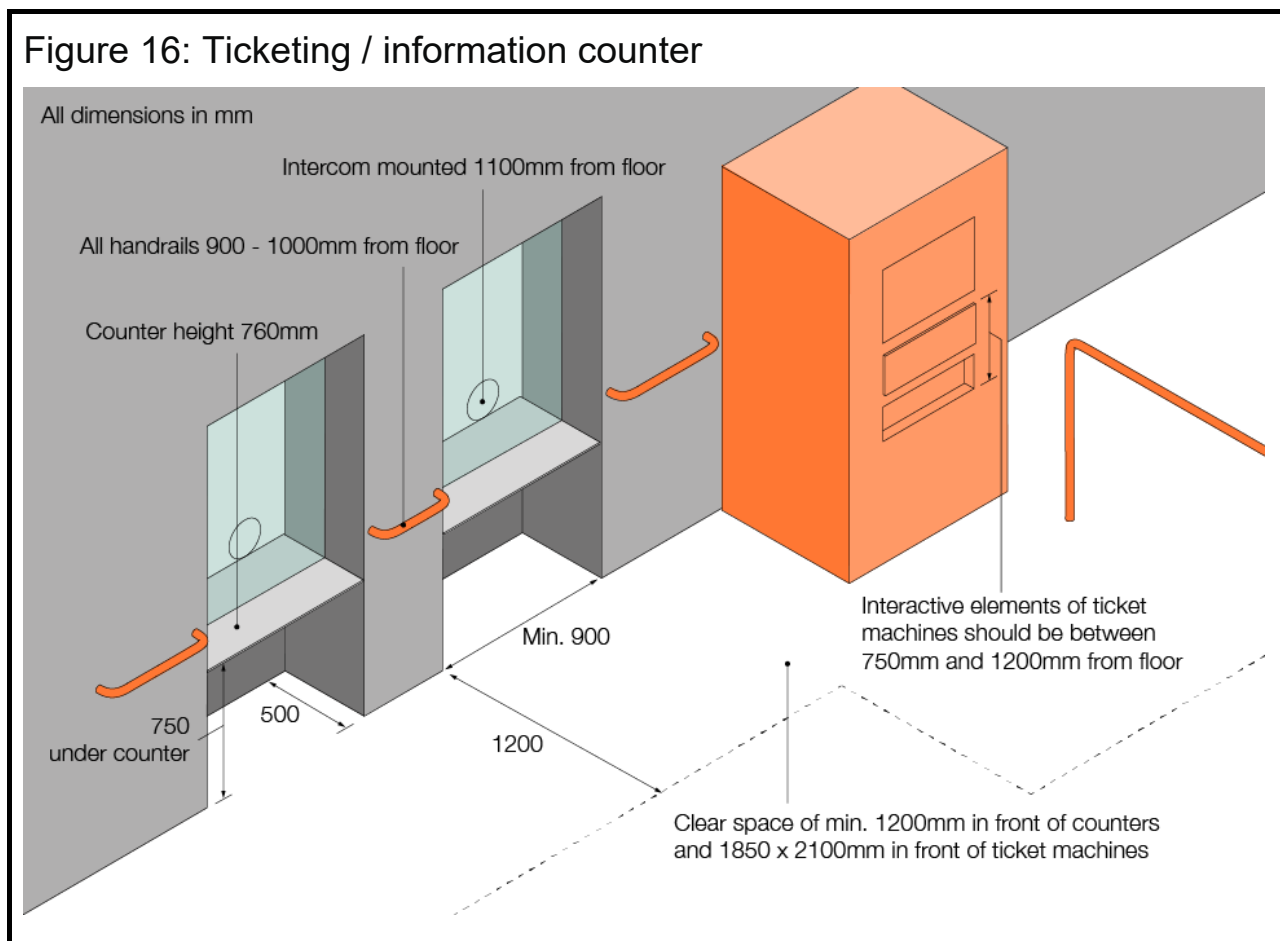

Instructions for the user should be clearly set out, with a minimum font size of **16 point**, using a mix of upper - and lower-case letters, and with unambiguous illustrations. All instructions should be presented so that they tonally and colour contrast with their background. Consideration should be given to providing a Braille version of any instructions. There should also be a good level of lighting around the machine; **200 lux** is recommended in the vicinity of the interactive parts. It is very important for there to be staff available to help people who find using ticket machines difficult, or even impossible.

11.5 Seating and the design of waiting and refreshment areas

Using public transport often involves waiting, so the provision of seating for passengers is vital. Because older and disabled people have varying needs, it is most important for different styles of seat, with a range of heights, to be provided. This should include some that are considerably lower than others,

for use by people who require a lower sitting position. There should also be some spaces among the seating that are accessible for wheelchair users so they can sit with their companions, rather than be segregated. The majority of seats should have a seat height of **470 to 480mm**. Armrests are helpful for some and should be at a height of about **200mm** above seat level. In any given row of seats, consistency is important, in that either all seats, or no seats, should have arm rests. This is because a mixture of designs within a row can cause difficulties for vision impaired people. Seats are recommended to have a minimum width of **500mm**.

There are some people who prefer perch-type seating to conventional seating, as it enables them to half lean and half sit. This type of seating is recommended to be at a height of **700mm**. Where there are constraints on the amount of space that is available for seating, fold down seats may be appropriate, in which case the seats should be at a height of **550 to 600mm**.

For outdoor seating, it is vital that rainwater should not collect on any part of the seat; installing wire top or wire mesh seats is one way of preventing this. Seats should be made of vandal-resistant, easy-clean material. As with other types of street furniture, seating should tonally and colour contrast with its surrounding area and should not obstruct pedestrian flows.

Waiting and refreshment facilities should make provision for the needs of disabled public transport users. There should be level access throughout, with, preferably, automatic doors at the entrance or doors that can be opened easily (Section 11.2). Priority seating for older and disabled people should be clearly identified and, where tables are provided, some should be accessible for wheelchair users too, with legroom that extends up to a height of **700 to 730mm** from the floor; this space should also be at least **600mm** wide and **500mm** deep. In order to be accessible for wheelchair users, the top of the table should be no more than **750mm** in height.

Gangways between tables should be a minimum of **1300mm** wide, to allow for the passage of wheelchair users and people who have an assistance dog, although a narrower width of **900mm** may be acceptable in circumstances where space is very limited. Tonally and colour contrasting seating and tables will assist vision impaired people, as will a tonal and colour contrast between the wall and the floor.

Figure 17: Waiting and refreshment facilities

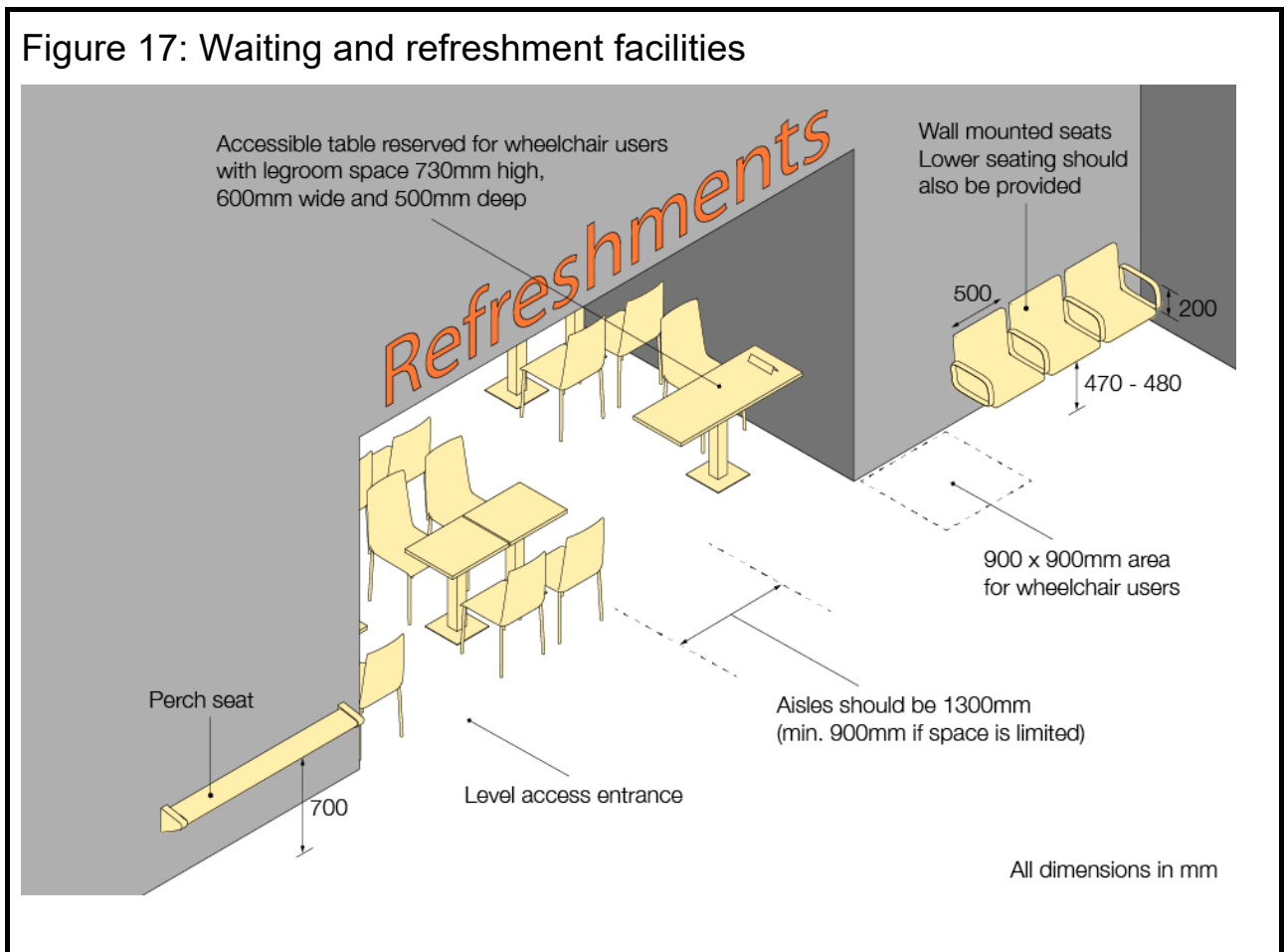

Counters should also be accessible, and so conform to the recommendations given in Section 11.4.

Waiting areas should be equipped with help buttons and visual / audio information points. When an audible announcement is made in waiting or refreshment areas, there should be an equivalent visual announcement for people who are deaf or who have a hearing impairment.

11.6 Luggage facilities

Where left luggage facilities are provided, they should be accessible for wheelchair users. Lockers of different sizes must be placed at heights appropriate to the range of passengers who wish to use them.

11.7 Toilets

Toilets should be no less available for disabled people than for non-disabled people. Accessible toilet facilities are important so that disabled people can travel with the same freedom, comfort and spontaneity as anyone else. Additionally, 'Changing Places' toilets are very important for many people who cannot use standard accessible toilets. Changing Places facilities have more space and additional equipment, such as a height-adjustable changing bench and a hoist. Standards for the design of Changing Places toilets can be found in Section 18.6 of BS 8300-2.

It is recommended that accessible toilets be designated as being non-gender-specific. This makes it easier for a disabled person to be accompanied in the toilet by a carer or partner of a different gender. It will help vision impaired people if there is an audio description of the layout of the toilet.

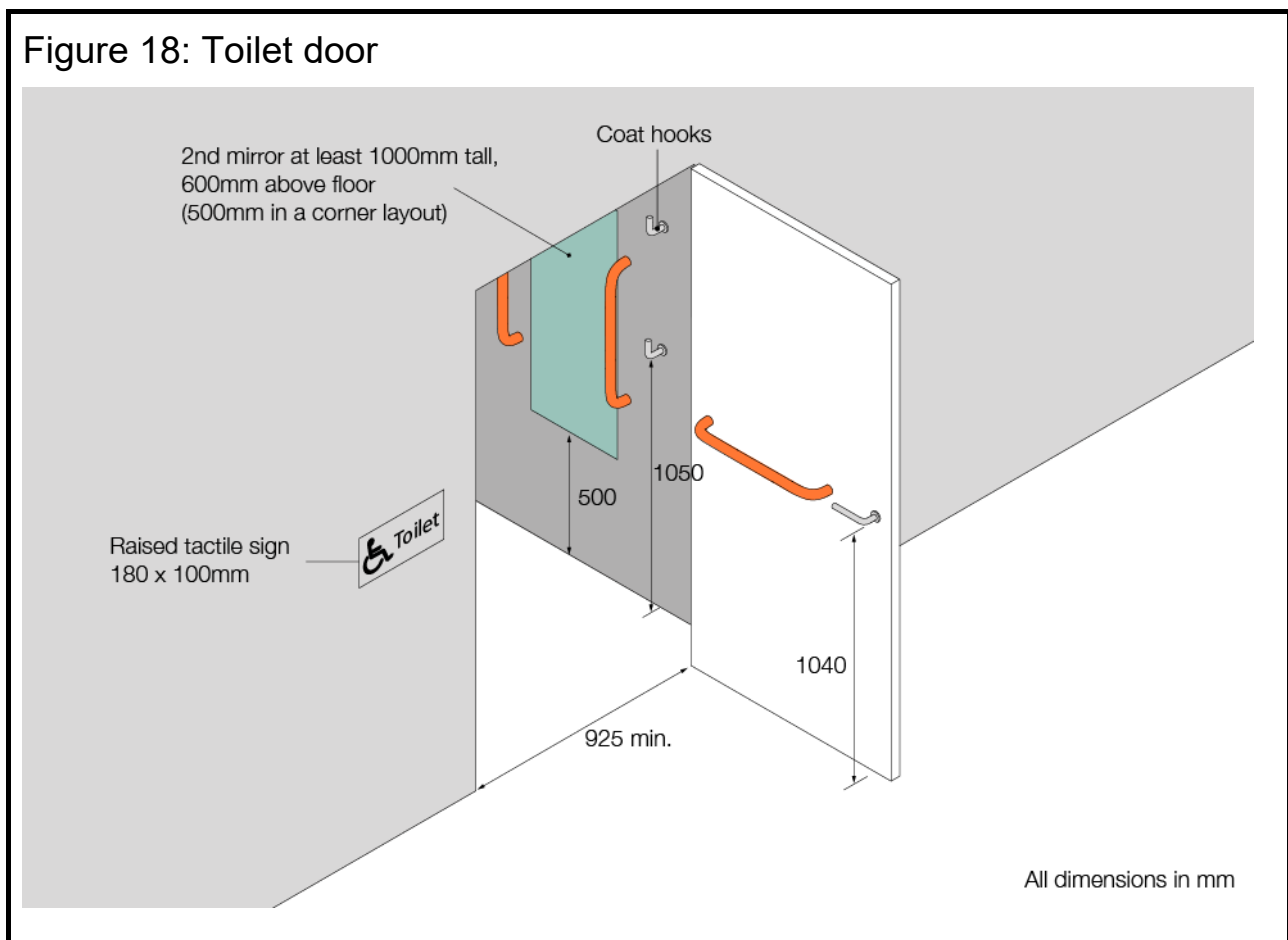
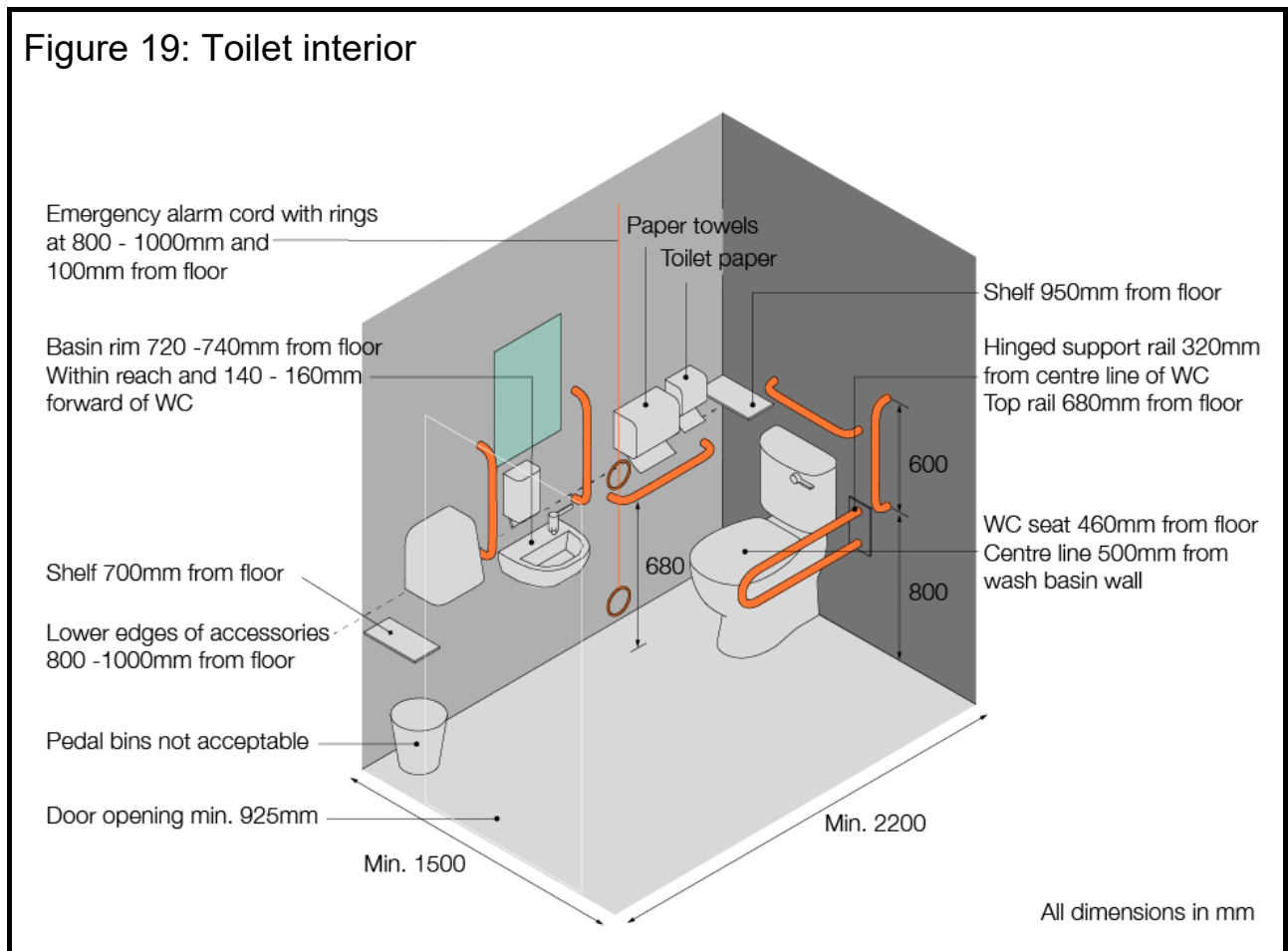

Figure 19: Toilet interior



Accessible toilets should be indicated by a raised tactile sign of **180mm x 100mm**. Toilet doors should have a minimum clear opening width of **925mm** and be fitted with 'L' or 'D'-shaped handles on the outside of the door at a height of **1040mm** above floor level (Figure 18). A horizontal closing bar should be fixed to the inside face of an outward opening door and the lock should be large and easy to operate.

The overall size of the toilet cubicle depends on whether it has a corner WC or a central (or peninsular) WC. A central WC allows the user to transfer from right or left, or from the front, onto the WC, in which case the toilet cubicle needs overall dimensions of **2800mm** (width) x **2200mm** (depth). With the WC positioned in the corner of the cubicle, the user can only transfer from one side of the WC, but less space is required: **1500mm** (width) x **2200mm** (depth) (Figure 19). With this layout, the WC centre line should be **500mm** from the side wall on which the wash basin is fixed. This basin should be within reach, placed **140 to 160mm** forward of the WC. Where more than one

accessible WC is provided, the opportunity should be taken to provide for both left-handed and right-handed transfer. The direction of transfer should be indicated by a touch-legible pictogram. The dimensions quoted in this paragraph are sufficient to allow a wheelchair user to turn around in a cubicle.

The WC should have a height of **480mm** and the rim of the wash basin should be **720** to **740mm** above the floor. If a separate basin is provided for non-wheelchair users, then the one closest to the WC can be at a lower level. Toilet paper, soap dispenser and a towel or hand drier should be within reach for a person seated on the WC. The wash basin should have a lever operated mixer tap on the side closest to the WC. A flushing lever attached to the WC cistern is preferable to a chain pull; where a corner WC layout is used this lever should be positioned on the transfer side of the WC. It should be noted that a peninsular layout does not allow the user to wash their hands while seated on the WC, unless a pivoting design of wash basin is used. A single accessible WC, with a peninsular layout, should not be seen as a substitute for two separate accessible WCs that give users a choice of whether to transfer from the left or the right.

A hinged (drop down) support rail should be provided on the transfer side of a corner-located WC, set at a height of **680mm**, **320mm** from the centre line of the WC. For peninsular layouts, a hinged handrail on each side is required. For corner layouts, there should be fixed support rails: one set horizontally, **680mm** above the floor on the wall at the side of the WC and two vertical rails set either side of the wash basin, each having a length of **600mm**, with the bottom end of each rail being **800mm** above floor level. If the WC cistern is a duct, or at a considerable height, a horizontal grab rail should be fitted behind the WC. All rails should be **35mm** in diameter, and their grip should be good when they are wet, with **60mm** clearance from the wall.

Accessories such as dispensers for soap, toilet paper and paper towels should be suitable for single-handed use and positioned with their lower edge between **800** and **1000mm** from floor level. A mirror should be placed immediately over the wash basin, with a second, longer mirror located away from the basin. This mirror should be at least **1000mm** tall, with the bottom edge **600mm** from the floor (**500mm** above the floor in a corner layout, where the viewing distance is more limited). A coat hook should be provided **1050mm** above floor level, so that it can be reached by a wheelchair user, and this should be provided in addition to a coat hook set at a more conventional height.

A colostomy changing shelf should be provided to the side of the WC, at a height of **950mm**, and a lower shelf, at a height of **700mm**, can be provided by the wash basin but clear of the wheelchair manoeuvring space.

An emergency alarm or Call for Assistance cord should be provided. This is normally red but should, in any case, tonally and colour contrast with its surroundings. This cord should be positioned to hang between the WC and the wash basin and should reach almost to floor level, passing through wall-mounted guides for ease of control. Two large pull handles (**50mm** diameter) should be attached to the cord, one at between **800** and **1000mm** from the floor and the other at **100mm** from the floor, so that assistance can be summoned by a person seated on the WC or from floor level if someone has fallen. It is recommended that the alarm reset switch be positioned inside the cubicle. The emergency alarm cord should be clearly labelled as such and should trigger audible and visual signals outside the cubicle and in a reception point or area that is staffed. The cubicle door should allow for opening from the outside in an emergency.

Where there are urinals, one should have a lower rim (maximum **430mm** from the floor). At this urinal, there should be a vertical rail on each side, to assist people who have the use of only one side of their body. A similar rail should be provided at the side of at least one standard height urinal. If a urinal is intended for wheelchair users, the rim height should be **380mm** from the floor and should project at least **360mm** from the wall. A tapering urinal, extending more than **360mm** from the wall to avoid contact with pipework, would allow closer access without the wheelchair touching the wall. An unobstructed space of not less than **900mm** (width) x **1400mm** (depth) should be provided in front of the urinal to enable a wheelchair user to manoeuvre.

Shiny surfaces are confusing for vision impaired people and should be avoided for walls, floors and doors etc. Matt and mid-sheen finishes are likely to maximise colour differentiation. There should be a good level of tonal and colour contrast between the floor and the walls, between the door and the walls, and between the toilet, washbasin and other fittings and their surroundings.

Guidance relating specifically to the provision of toilets in managed railway stations can be found in Network Rail's Public Toilets in Managed Stations.

11.8 Provision for assistance dogs

It is important to people who travel with an assistance dog that relief areas should be provided for their dog. For this purpose, a secure area should be provided close to station buildings, with a step-free access route to it. This area should be at least **3000mm x 4000mm**, surrounded by a secure fence **1200mm** in height. The entrance gate to the enclosed area should have a catch that is secure and simple to operate. The surface of the area should be concrete, with a smooth finish to assist cleaning, and a slight fall, of approximately **1 in 30**, to assist drainage. A waste bin (Section 4.7) with a supply of plastic bags should be placed close to the entrance of the area, where there should also be a sign, in tactile embossed letters and braille, saying: "For assistance dogs".

12. The use of digital technology in public transport

Digitally provided information and communications technology (ICT) is increasingly enhancing the accessibility of public transport infrastructure and the pedestrian environment. This section focuses on ICT commonly used in public transport: touchscreens, contactless ticketing, real-time information and wayfinding technologies.

ICT has the potential to greatly improve and enhance the journey experience for public transport users. This includes supporting wayfinding, supporting intra-station navigation, and providing passengers with accessibility data about stations and stops so they can make informed travel choices regarding accessibility of services. It is important that access to these benefits are not hindered by confusing or otherwise unusable functionality or user interface. roadside information and hard copy formats are also important for many passengers, including if ICT services are out of order.

This section focuses on the important principles of the accessibility of ICT related to the accessibility of public transport infrastructure and the pedestrian environment and why it is important for technologies to be simple and intuitive to use for as many people as possible.

ICT is underpinned by standards that relate to the design and technical specification of devices and equipment and the accessible design of devices and equipment. Details of the design or performance requirements for ICT are available from various organisations including ISO publication ISO/IEC 30071-1:2019, is a code of practice for creating accessible ICT products and services. Further advice and support on achieving accessible approaches is available on GOV.UK, and from reviewers such as the Digital Accessibility Centre.

12.1 Touchscreens

Touchscreens have become an increasingly common interface, with everyday public transport examples including touchscreens for information terminals and ticket vending machines.

The advantage of touchscreen technology is that a screen can be used for a large number of functions and can replace a number of buttons. However, not all people will find such user interfaces accessible. Someone who is blind, for example, will not be able to use a touchscreen without audio instructions. Furthermore, as a touch screen does not provide tactile feedback to the user, it can be helpful to have audible feedback even though this might not be audible to some people with a hearing impairment.

It is important that touchscreens be shielded from sunlight and be perpendicular to the line of sight. Guidance in Section 11.4 (on Ticketing and information) that any interactive element of a machine should be between **750mm and 1200mm** from the ground applies to touchscreens.

It is important to consider the legibility of information displayed. Text and icons should be tonally and colour contrasted with their background, such as white or yellow type or pictograms on a black or dark background is ideal. Touch-sensitive areas of the screen ('buttons') should similarly have tonal and colour contrast with their background, and there should be some inactive space around each 'button'. Common understanding of colour should be adhered to, such as red to convey the message "Stop".

Symbols or icon appearing on the display should be identified by accompanying text, and there should be a clear, visual means of distinguishing such labels from control 'buttons'.

It is important that text and 'buttons' should not be positioned on the screen over background patterns or images, as this can make text difficult to read. All text should be in 'plain English', with short and simple phrases or sentences. If possible, abbreviations should be avoided.

Audio instructions and other information, synchronised with visual outputs, will assist users including vision impaired people.

Feedback to the user that a 'button' has been touched and a command entered will provide reassurance that the system is responding to instructions.

Accessibility is improved when a touchscreen can be operated using a mouth stick, headstick or similar stylus, and when users can input commands by voice only.

Designs should accept that users will make mistakes and provide the user with clear and unambiguous control and permit them to go back a step when required, clearly indicating how this might be done.

Providing help for the user, when requested, is also very important. Such assistance given should be specific information relevant to the task being undertaken. 'Help' information should be readily distinguishable from other text provided on screen and help the user recover from errors. Help might be available through voice messages, as well as text, with short and simple sentences, and with a member of staff to be available near information terminals and ticket machines, to provide any help that is required.

Key international standards relating to touchscreens and similar displays are ISO 9241-303:2008 and ISO 80416-4:2005.

12.2 Contactless ticketing

Many public transport operators have introduced contactless ticketing options, sometimes via smartphone. It is important these support all potential users take advantage of the benefits of contactless ticketing.

Systems need to be designed so they provide accessible and efficient means for users to access information such as that needed on journeys paid for and on the credit they have left.

Distinguishing a ticketing card from, for example, a bank card can help if it is provided with Braille or raised numbers and lettering.

It is important that the positioning and features of equipment, such as a card readers, are conspicuous and with consistent layouts. and as intuitive as possible, and well explained to users and potential users.

Alternatives and assistance should be available for people who are not able, or choose not, to use the technology.

12.3 Real-time information

Real-time information (RTI) is increasingly provided by a number of means in stations and interchanges, on transport vehicles, at stops, and direct to passengers through smartphone apps and websites. It is important that **RTI**

equipment is accessible and that regular maintenance and tests ensure information continues to be provided correctly.

RTI displays should be designed and installed so that they are accessible and effective even when environmental conditions change. This can be achieved if certain key principles are adhered to. For example, it is important that text is tonally and colour contrasted with its background, and that any icons and symbols used are easily identifiable (Section 13). For optimal clarity, text and colours should adjust depending on the environment's ambient lighting. Account must also be taken of colour deficiencies - a red/green combination should be avoided, for example.

Both audio and visual information should be provided wherever possible. This is because visual information alone will not be accessible for most vision impaired people. All messages should be clear, concise and consistent, and care should be taken not to overload public transport users with information.

Some displays, such as those used to show real time information on services, constantly change in a cyclical manner. This may be done either by switching from one piece of information to another in a given information field, or by scrolling. For such displays, each item of information, which might be a destination name or a platform number, should be displayed for a minimum of **2 seconds**. If a scrolling mechanism is used, whether information moves vertically or horizontally, each complete word shall be displayed for a minimum of **2 seconds**. Messages that scroll horizontally shall have a maximum speed of **6 characters per second**. Importantly, advertising messages and displays should not appear on the same screen as important travel information. The location of signs is also important: they should be positioned in places where they can be seen most easily, avoiding glare or poorly lit locations.

Other recommendations for real-time information displays are as follows:

Electronic characters: these can be formed by segments or dots. Increasing the number of dots or segments improves character readability. Specific recommendations concerning electronic characters can be found in the following table.

7 segments	Numerical information only
14 segments	Preferred for general applications

Segmented displays

5 x 7 matrix	Minimally acceptable
7 x 9 matrix	Preferred for general applications
8 x 11 matrix	Minimum if symbols are rotated
15 x 21 matrix	Preferred if symbols are rotated

Dot matrix displays

Height of characters: it is recommended that character height should be equal to the distance between the viewer and the screen, divided by 137.5. Thus, if viewed from **2 metres**, character height should be approximately **14.5mm**; at **10 metres** it would be about **73mm**.

Electronic signs outside buildings should be shielded from direct sunlight. Care should be taken to ensure that information displays are accurate and up-to-date.

12.4 Wayfinding technologies for pedestrians

Wayfinding to help navigation through the pedestrian environment and public transport facilities, including to and through the public transport network, is of value to all people including vision impaired people. Increasingly technological solutions are being developed which gather relevant information and use it to inform wayfinding, orientation, navigation and task completion.

Technological solutions should be fit for purpose for vision impaired people, and validated through comprehensive user testing. These should deliver

information in appropriate ways and languages suited to potential users. These should also provide users with an intuitive interface where they can set preferences such as the means by which they prefer to receive information, and be capable of being used in conjunction with existing mobility and orientation aids, and by someone accompanying a vision impaired user.

Wayfinding solutions should have the capability to provide either static information (e.g. the location of toilets) or dynamic information (e.g. details of public transport services in real-time), relevant to the user's location and direction of travel over an entire journey to and from home.

Any solution must also be able to blend with others, given that there is no single technology that meets all the requirements of an individual, and should be compatible with emerging technologies.

Although there is currently no standard covering the usability of digital wayfinding solutions, the 'Wayfindr' Open Standard does define best practice for the implementation of audio-based navigation systems based on messaging. Wayfindr's Open Standard has been adopted by the International Telecommunications Union (ITU), to become an ITU recommendation whilst remaining open. The existence of this Open Standard increases the probability of the development of seamless and consistent wayfinding systems for vision impaired people in the future.

Consideration should also be given to adopting approaches for wayfinding such as consistency of design, so that ICT solutions are not needed to address shortcomings. Examples include ensuring all lift button layouts are the same across a network and consistency in the location and design of information points and help desks in stations and interchanges. Audible announcements might also be used to help vision impaired people identify platforms via audio cues, particularly in major stations and interchanges. The creative use of lighting might also help people with spatial orientation.

13. Signing and information

It is important that signs provide accessible information with continuous chains of directional information and other public information provided on public transport networks including notifications of service changes and emergency announcements.

Signs and information must be in forms that can be used by disabled people. It is particularly important to take account of the needs of vision impaired and hard of hearing people and to make information as simple and easily understood as possible. Simplicity helps everyone. The placing of signs is also important: reasonably close to, but not impeding passenger circulation areas.

Signage has a very important role to play. It should encompass all the facilities within the area, particularly services, information desks, and facilities for disabled people such as accessible toilets, and should also say how far it is to each facility mentioned.

Information of particular importance relating to emergencies such as emergency exit routes must be clearly signed and alarm systems used for emergencies should have flashing warning lights essential for people who may not be able to hear an alarm or emergency announcements.

Public announcements should be conveyed in both audible and visual form, to ensure that information is provided for people who are vision or hearing impaired. Verbal and text messages should be precise and include key information in clear language. There should also be consistency between audible and visual messages.

Guidance on information displays is included in Chapter 12.

13.1 The size of text and symbols on signs

The size of letters should be related to the distance from which the sign will usually be read.

Research studies have produced a range of preferred size of letters in relation to distance and degree of visual impairment. As a general rule, it is suggested that the letter height should be at least **1%** of the distance at which the message will usually be read, subject to a minimum height of **22mm**. If space permits, letter height should be greater than 1%.

The Sign Design Guide (see Bibliography) recommends the following character sizes:

- long distance reading, for example at building entrances, a minimum size of **150mm**
- medium range reading, for example direction signs in corridors, a size of **50 to 100mm**
- close up reading, for example wall mounted information signs, a size of **15 to 25mm**

The Sign Design Guide also makes recommendations relating to the relationship between character size and reading distance. For someone with 6/60 vision, who is registered as partially sighted, the character size to reading distance ratio is approximately **1:27**. Thus, at a distance of 4 metres, character size would need to be **150mm**; at 6 metres it would be **225mm**.

The original Inclusive Mobility and the table below was informed by research by TransVision for Transport Canada, relating viewing distance to symbol size. The size is actual for any square symbol and nominal for symbols using a circular or triangular shape. Symbols can have the advantage of simplicity and greater clarity but should not be used unless they will be understood by passengers and staff.

Viewing distance (metres)	Symbol size (mm)
3-6	40
6-9	60
9-12	80
12-15	100
15-18	120
18-24	160
24-30	200
30-36	240
36-48	320
48-60	400
60-72	480
72-90	600

Viewing distance and symbol size

13.2 Choice of fonts

In general, a sans serif font will be the most accessible. In addition, mixed case lettering provides the most accessible form of text, with sentences and individual words being easier to read if they are presented in a combination of lower - and upper-case characters. This is because, for vision impaired people, or people who have dyslexia, or if a sign is read from a distance, it is often possible to recognise a word from its 'shape', even if individual letters cannot be distinguished.

13.3 Tonal and colour contrast

It is essential that there should be a tonal and colour contrast between the characters on a sign and the sign's background. Apart from signs that are

internally lit, dark text on a light background is preferable: e.g. black or dark blue on a white background. A fuller discussion of tonal and colour contrast, and its importance in terms of accessibility, has been provided in Section 4.1. Signs should have a matt finish, not a reflective one, and should be well and evenly lit with uniform lighting over the surface of the sign of between **100** and **300 lux**.

13.4 Positioning of signs

Viewing angle is important to the legibility of signs. The optimum viewing angles for signs mounted on walls or other vertical surfaces are $\pm 30^\circ$ in the vertical plane (from eye level¹) and up to 20° either side of a 90° line to the sign in the horizontal plane. In practice, however, it may be neither possible nor desirable to place signs at a height that corresponds to this definition of 'optimum viewing', because other factors need to be taken into account, such as the issue of obstruction from other passers-by. Where a sign may be obscured in this way, it should be placed at a height of not less than **2000mm**. Where a directional or information sign is suspended over a pedestrian area, there should preferably be a **2300mm** clear space below the bottom edge of the sign (**2100mm** minimum).

Wall-mounted signs that contain detailed information, such as timetables, maps and diagrams, should be centred approximately **1400mm** from the ground, with the bottom edge not less than **900mm** above ground level and the top edge at a height of no more than **1800mm**. Consideration should be given to duplicating detailed signs and instructions, especially safety notices, so that one is centred at a height of **1600** to **1700mm** and another is centred at **1000** to **1100mm** to allow convenient close viewing by wheelchair users and other disabled people who require signs to be at a lower height.

13.5 Tactile signs and labelling

All information intended to be read by tactile means, whether in the form of words or pictograms, should be embossed (i.e. raised), not engraved, and should be raised from the surface of the sign by **1** to **1.5mm**. The stroke width

¹ The average eye line of a standing person (but not a wheelchair user, of course) is 1,400 to 1,700mm from the ground, according to: Department for Transport / Transport Scotland (March 2015), Design standards for accessible railway stations: A joint Code of Practice by the Department for Transport and Transport Scotland.

(of non-Braille characters) should be **1.5 to 2mm** and each character should be at least **15mm** in height. The letter spacing of raised characters should be increased by **20 to 30%**, depending on the font used, and word spacing should be increased by **25%**. The edges of embossed characters should be slightly rounded, to avoid sharp edges, and the typeface should be a sans serif font.

Where Braille is used, grade 1 Braille is permissible for single words but for signs with more than one word contracted (grade 2) Braille must be used. It should be noted, however, that only approximately 10% of vision impaired people read Braille², so embossed signs will generally be more useful.

13.6 Audible information

Audible announcements are helpful to most and particularly to vision impaired people. It is essential that there is a significant difference between the level of background noise (ambient noise) and the level of the signal or announcement. The higher the signal to noise ratio, (i.e. the difference in decibels (dB) between the signal or announcement and the background noise level), the clearer the message will be. People with a hearing impairment require a sound to noise ratio (S/N ratio) of at least **+5dB**. In environments that are noisy, any spoken information should be repeated at least once.

Audible alarm systems should operate at least **15dB** over the prevailing sound level, to a maximum of **120dB**.

13.7 Timetables

In spite of the increasing availability of real-time information on public transport services, via the internet or direct to public transport users' smartphones, printed timetables on display at interchanges, stations and stops remain valuable to many people, and so should continue to be provided. To further help travellers, all interchanges and stations should have clocks that display the current time in large, digital characters. Rail timetables and most bus timetables use a 24-hour format, so this format should also be used for clocks associated with public transport facilities.

² <https://www.rnib.org.uk/professionals/knowledge-and-research-hub/key-information-and-statistics> Last accessed on 22 November 2020.

Timetables and other information that people will read from a short distance should use:

- a simple Sans-Serif, mixed case typeface
- a print size of **16 point** (if there is sufficient space)
- good contrast between print and background, e.g. black on white or black on yellow
- matt finish paper (not glossy)

If appropriate, the information should distinguish clearly between weekday and weekend services. In some cases, the amount of timetable information to be displayed will require smaller font sizes, rather than 16 point characters. The other requirements listed above would still apply. Where text is used it should be left-aligned and with a ragged right-hand margin; this is easier to read than justified type. Although a word or two in capitals should not present any difficulties, capitals should be avoided in continuous text.

Timetables placed outside, for example at bus stops, should, if possible, be sheltered from the rain; water on the glass over the timetable distorts the text and makes it difficult to read. All bus stops should be provided with timetable frames located between **900** and **1800mm** above ground level. Timetable panels, of the type found in railway stations, should be placed adjacent to the main flow of passenger circulation, and at right angles to the direction of flow. Placing should allow passengers to stand directly in front of the panel without impeding the main circulation. The recommended dimensions for the panels are: bottom **900mm** above ground, top **1800mm**, width **800mm** to **1100mm**. If there is an opening between the bottom of the panel and the ground, a skirting **300mm** minimum in height should be placed below the panel to guide people who use a long cane or stick around the panel.

Further information on good practice concerning the design and presentation of public transport timetable information can be found in an Association of Transport Co-ordinating Officers (ATCO) publication entitled Printed Information at Bus Stops.

14. Lighting

Good lighting is important for all and particularly for disabled people for reasons including personal security, the feeling of being safe, and for helping people see and read signs and instructions. Vision impaired people have a greater need for clarity from lighting systems, since reflection, glare, shadows and substantial variations in lighting levels can cause some visual confusion and discomfort.

Reflection can be minimised with the careful use of non-reflective finishes on internal surfaces, while glare can be reduced by the thoughtful positioning of lighting out of the line of people's vision. Glare from daylight can be reduced with adjustable blinds on windows. Shadows can mask hazards; they can be avoided by increasing ambient light levels and ensuring spotlights are not used in isolation. Similarly, feature lighting, such as downlighters, should not cause shadows to fall across a staff member's face, at a ticket counter, for example, thereby making lip reading difficult. Large variations in lighting levels requiring swift reactions from the eye should be avoided, with any changes in illumination being gradual.

Lighting often fulfils secondary functions, such as giving directional guidance, e.g. along a corridor illuminated by a series of lamps mounted in a straight line on the ceiling. Such lighting can help vision impaired people orientate. Lighting might also highlight a potential hazard, such as a flight of stairs. Bright, well-lit premises will encourage the use of public transport and lighting that eliminates dark areas or corners will engender greater feelings of security in passengers. Wherever possible, buildings should be designed to make maximum use of natural light, subject to minimising glare and strong reflections off surfaces.

Detailed recommendations for lighting, which are for roads and public amenity areas, can be found in BS 5489-1:2020. The key sections of this Standard in the context of public transport environments are Section 7.4.6, Table 2 (Lighting levels of shopping arcades and canopy areas), Section 7.4.7, Table 3 (Lighting levels of subways, footbridges, stairways and ramps) and Section 7.4.8, Table 4 (Lighting levels for outdoor car parks).

The following is a list of recommended minimum acceptable illumination levels:

Location	Minimum illumination level
Entrances to buildings	150 lux
Passages and walkways	150 lux
Steps and stairs, at tread level	200 lux
The top and bottom of ramps	200 lux
Station platforms and forecourts	50 lux
Underpasses	50 lux
Where there are directional signs	200 lux
Where there are maps and displays	200 lux
Counter tops	250 lux
Where there is a control panel	100 lux
Ticket machines etc.: interactive area	200 lux
Ticket machines etc.: surrounding area	50 lux
Inside lifts (uniformly distributed)	100 lux
Landing area of lifts	200 lux
Accessible toilets	100 lux

Minimum illumination levels at various locations

15. Access in the countryside

Although most of this document refers to the urban environment, accessibility of facilities in the countryside is also important.

Those involved in the design, planning and provision of access to the countryside should consult Paths for All's Countryside for All Good Practice Guide: A guide to Disabled People's Access in the Countryside. This incorporates the British Telecom (BT) Countryside for All Standards and Guidelines (1997) and has replaced the 2005 Fieldfare Trust document entitled Countryside for All Good Practice Guide – A Guide to Disabled People's Access to the Countryside.

To allow for two-way pedestrian traffic, paths should be at least **2000mm** wide with a clear visual distinction between the path surface and the ground next to it. If the path width has to be less than 1500mm, passing places (minimum **1500mm (wide) x 2000mm (long)**) should be provided every **50 metres**.

In principle, all paths should be uninterrupted by obstructions such as steps, stiles and fences and there should be a clear tonal and colour contrast between the path and the ground next to it. The maintenance of a clear and obstruction-free space, or 'tunnel', that is at least **2100mm** in height is recommended.

The Countryside for All Good Practice Guide: A guide to Disabled People's Access in the Countryside defines two main types of non-urban context in which its recommendations apply: 'Urban fringe and managed landscapes', such as countryside areas near towns or managed recreation sites; and 'Rural and working landscapes', such as farmland and woodland with public rights of way. It recommends that there should be a resting place at least every **200 metres** in 'Urban fringe and managed landscapes' and at least every **300 metres** in 'Rural and working landscapes'. The gradient of paths in these two contexts should not exceed **1 in 12** and **1 in 10**, respectively. There should also be level landings provided on all paths that have a gradient in excess of 1 in 20. Each landing should consist of a space with minimum dimensions of **1200mm (wide) x 1500mm (long)**, and a landing should be provided for every **750mm** of vertical climb. It is also important to minimise

crossfalls on rural paths; the slope across a path should be a maximum of **1 in 45** in 'Urban fringe and managed landscapes' and a maximum of **1 in 35** in 'Rural and working landscapes'.

All path surfaces should be compact, firm and stable. Suitable materials include concrete, bitumen macadam, stone, timber, brick/paving and mown grass. Loose sand or gravel, woodchips and cobbles should not be used.

Seats and perches should be placed at regular intervals along paths in the countryside. They should be located no more than **100 metres** apart and set back from the main route by at least **600mm** to allow the free passage of through traffic. Surfaced resting places at least **900mm square** should be provided next to seats so that wheelchair users can sit next to family and friends.

Where there are gates on a path, there should be clear space **2000mm** long, with **300mm** extra width adjacent to the latch side, on the side of the path into which the gate opens.

Bridges and boardwalks should have a minimum clear width between handrails or edging boards of **1200mm** for one-way traffic and **2000mm** for two-way traffic. At the start of a boardwalk the lip should not be more than **5mm** high and gaps between boards (laid at right angles to the directions of pedestrian flow) should not be more than **12mm** wide. All boardwalks and bridges should have edge protection at least **75mm** high and also handrails. The top of each handrail should be at a height of between **900mm** and **1000mm** above the surface of the bridge or boardwalk.

Figure 20: Rural bridge

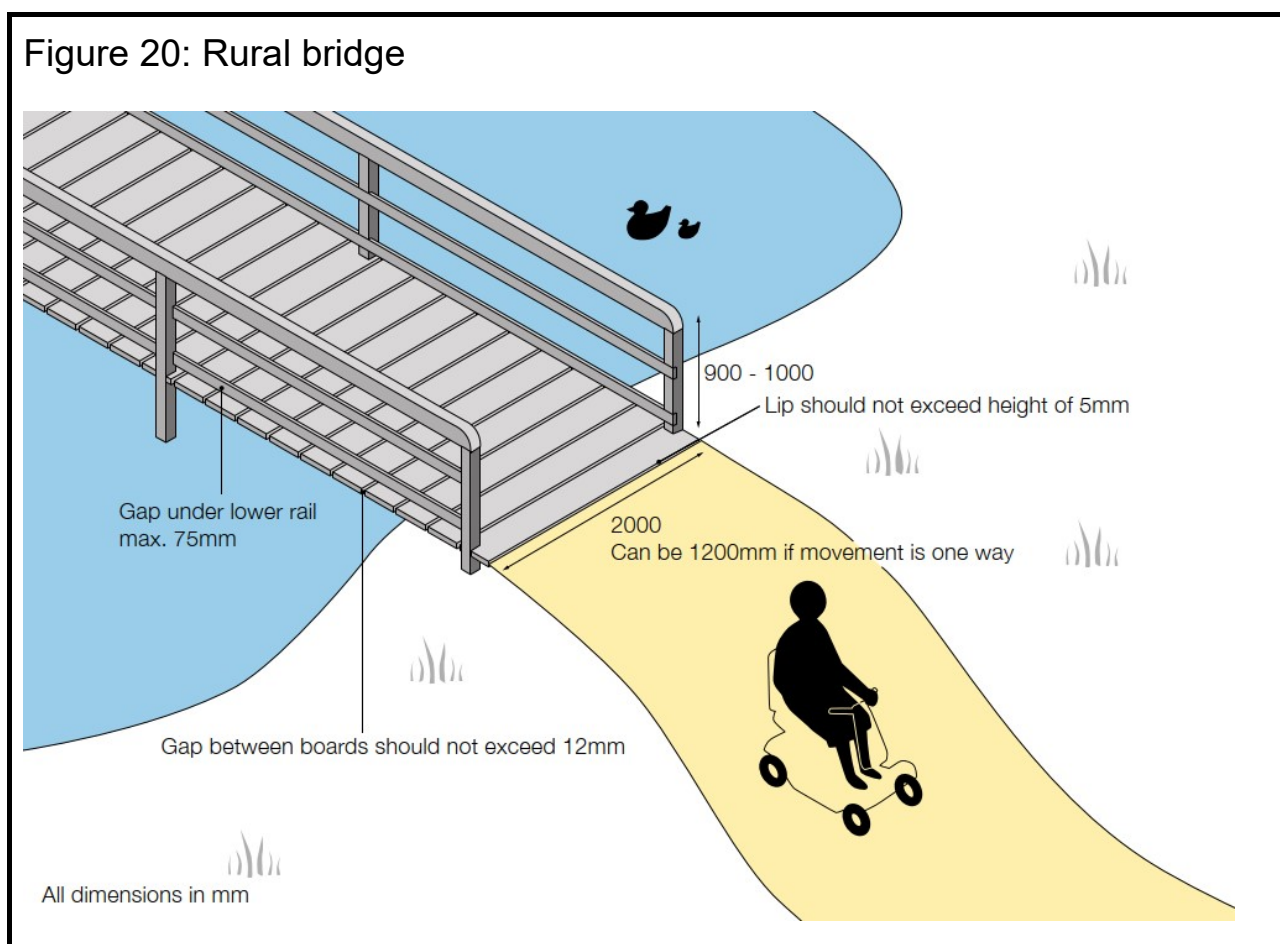

Viewing points should, wherever possible, be accessible to everyone, including wheelchair users. The provision of seating or resting places is important, as is ensuring that any information or interpretation points do not obscure the view for wheelchair users. If telescopes are provided, they should have a variable height control and there should be knee space between the telescope and the ground to give wheelchair users access. Safety barriers should be provided, where necessary, and should take account of the viewing height of wheelchair users, though safety considerations are paramount.

Sheltered information and interpretation boards are helpful for visitors and can double up as shelter from the weather. They should be accessible to all visitors and, where possible, incorporate seats or perches under the shelter. The roof of the shelter should not just cover the information board, but also people reading it. The roof should be at least **2100mm** from the ground so that it is not a hazard for vision impaired people.

Glossary

ATCO	Association of Transport Co-ordinating Officers
BS	British Standard
Carriageway	The part of the highway (other than a cycle track) that is intended for use by vehicles and on which they have a right of way
CCTV	Closed-circuit television
Footpath	A route on which pedestrians have a right of way, not being a footway.
Footway	The part of the highway over which there is a right of way for pedestrians only (including users of wheelchairs and mobility scooters), and which runs alongside a carriageway intended for use by vehicles.
ICT	Information and Communications Technology
ISO	International Standardisation Organisation
ITU	International Telecommunications Union
Landing	A level space at the top or bottom, or between consecutive flights, of steps or sections of a ramp where pedestrians may rest.
LED	Light Emitting Diode
LRT	Light Rapid Transit
LTN	Local Transport Note
Neurodiverse	Neurodiverse, or neurodivergent, refers to the normal diversity of human brains and the infinite variation in people's neurocognitive functioning. The term is commonly used to describe conditions such as autism, dyslexia,

dyscalculia, Attention Deficit Hyperactivity Disorder (ADHD) and Obsessive Compulsive Disorder (OCD).

RNIB	Royal National Institute of Blind People
RNID	Royal National Institute for Deaf People
RTI	Real-Time Information
TAL	Transport Advisory Leaflet
TSRGD	The Traffic Signs Regulations and General Directions 2016
VSB	Vehicle Security Barrier

Bibliography

Association of Transport Co-ordinating Officers (ATCO) (November 2004)
Printed Information at Bus Stops. Interim Good Practice Guidelines.

BRE (2003) IP 15/03 Proprietary Nosings for Non-domestic Stairs.

British Standards Institute (1995) BS 7818:1995 Specification
for Pedestrian Restraint Systems in Metal.

British Standards Institute (2017) BS 9999: Code of Practice for Fire Safety in
the Design, Management and Use of Buildings.

British Standards Institute (2017) BS EN 16584:2017 Railway Applications.
Design for PRM Use. General Requirements.

British Standards Institute (2018) BS 8300-1:2018 Design of an Accessible
and Inclusive Built Environment. Part 1: External Environment – Code of
Practice.

British Standards Institute (2018) BS 8300-2:2018 Design of an Accessible
and Inclusive Built Environment. Part 2: Buildings – Code of Practice.

British Standards Institute (2020) BS 9992:2020 Fire Safety in the Design,
Management and Use of Rail Infrastructure. Code of Practice.

British Standards Institute (2020) BS EN 81-20:2020 Safety Rules for
the Construction and Installation of Lifts. Lifts for the Transport of Persons
and Goods. Passenger and Goods Passenger Lifts.

British Standards Institute (2020) BS 5489-1:2020 Design of Road Lighting.
Lighting of Roads and Public Amenity Areas. Code of Practice.

British Standards Institute (2021) BS EN 17210:2021 Accessibility and
Usability of the Built Environment. Functional Requirements.

British Standards Institute (2021) BS EN 81-70:2021 Safety Rules for the
Construction and Installation of Lifts. Particular Applications for Passenger
and Goods Passenger Lift. Accessibility to Lifts for Persons including Persons
with Disability.

Building Regulations (2016) Approved Document M: Access to and Use of Buildings.

Department for Transport (December 2003) Traffic Advisory Leaflet 7/03: Public Transport Information.

Department for Transport (April 2009) Local Transport Note 2/09: Pedestrian Guardrailing.

Department for Transport (July 2009) Guidance on Local Transport Plans.

Department for Transport (May 2013) Traffic Advisory Leaflet 2/13: Bollards and Pedestrian Movement.

Department for Transport (October 2013) Safety at Street Works and Road Works: A Code of Practice.

Department for Transport (January 2015) Traffic Advisory Leaflet 1/15: Variable Message Signs.

Department for Transport / Transport Scotland (March 2015) Design Standards for Accessible Railway Stations: A Joint Code of Practice by the Department for Transport and Transport Scotland.

Department for Transport (May 2016) DfT Circular 01/16: The Traffic Signs Regulations and General Directions 2016.

Department for Transport (April 2017) Local Cycling and Walking Infrastructure Plans: Technical Guidance for Local Authorities.

Department for Transport (2018) The Inclusive Transport Strategy: Achieving Equal Access for Disabled People.

Department for Transport / Department for Infrastructure (Northern Ireland) / Scottish Government / Welsh Government (2019) Traffic Signs Manual.

Department for Transport (July 2020) Local Transport Note 1/20: Cycle Infrastructure Design.

Department for Transport (January 2021) National Technical Specification Notice. Persons with Reduced Mobility (PRM NTSN).

Department for Transport - Guidance on the Use of Tactile Paving Surfaces.

[Electrically Assisted Pedal Cycles Regulations \(1983\).](#)

[Equality Act \(2010\).](#)

European Commission, COST Action 335 (1991) Passengers' Accessibility to Heavy Rail Systems. Part 1.

[Highways Act \(1980\).](#)

GOV.UK Making your service accessible: an introduction
(www.gov.uk/service-manual/helping-people-to-use-your-service/making-your-service-accessible-an-introduction#further-reading)

International Standards Organisation (2005) ISO 80416-4 (2005).
Basic Principles for Graphical Symbols for Use on Equipment. Part 4 -
Guidelines for the Adaptation of Graphical Symbols for Use on Screens
and Displays (Icons).

International Standards Organisation (2008) ISO 9241-303:2008: Ergonomics
of Human-system Interaction – Part 303: Requirements
for Electronic Visual Displays.

International Standards Organisation (2019) ISO/IEC 30071-1:2019:
Information Technology — Development of User Interface Accessibility —
Part 1: Code of Practice for Creating Accessible ICT Products and Services.

International Telecommunications Union (March 2017) ITU-T F.921: Audio-
based Network Navigation System for Persons with Vision Impairment.

Joint Mobility Unit and the Sign Design Society, RNIB (2000) Sign Design
Guide.

[Local Transport Act \(2008\).](#)

Network Rail (2020) Public Toilets in Managed Stations. NR/GN/CIV/200/04

Network Rail (2021) Inclusive Design. NR-GN-CIV-300-04

Paths for All (February 2005) Countryside for All Good Practice Guide – A Guide to Disabled People’s Access to the Countryside.

[Public Sector Equality Duty \(2011\).](#)

[Public Service Vehicles Accessibility Regulations \(2000\).](#)

Rail Vehicle Accessibility (Non-interoperable Rail System) Regulations. Disabled Persons Transport (2010).

TOPAS Group (2020) TOPAS 2508C: Performance Specification for Tactile Equipment for Use at Pedestrian Crossings.

[Traffic Signs Regulations and General Directions \(2016\).](#)

Transport Research Laboratory (1994) Design Guidelines for Public Transport Infrastructure - Technical Report to Transport Research Laboratory, Project Report 83.

Transport Scotland (July 2013) Roads for All – Good Practice Guide for Roads.

Transport Scotland (July 2020) Cycling by Design.

Wheels for Wellbeing (2020) A Guide to Inclusive Cycling (4th Ed.)